

Schema FacturaElectronica.xsd

schema location: <e:\Documents\NetBeansProjects\Ministerio de Hacienda\xml-schemas\FacturaElectronica.xsd>
attributeFormDefault: **unqualified**
elementFormDefault: **qualified**
targetNamespace: <https://www.hacienda.go.cr/ATV/docs/esquemas/2016/v4/facturaElectronica>

Elements	Complex types	Simple types
FacturaElectronica	CodigoType EmisorType ExoneracionType IdentificacionType ImpuestoType ReceptorType TelefonoType UbicacionType	ClaveType DecimalDineroType NumeroConsecutivoType UnidadMedidaType

schema location: <C:\Program Files\Altova\Common2016\Schemas\xmlsig\files\xmlsig-core-schema.xsd>
attributeFormDefault:
elementFormDefault: **qualified**
targetNamespace: <http://www.w3.org/2000/09/xmlsig#>

Elements	Complex types	Simple types
CanonicalizationMethod DigestMethod DigestValue DSAKeyValue KeyInfo KeyName KeyValue Manifest MgmtData Object PGPData Reference RetrievalMethod RSAKeyValue Signature SignatureMethod SignatureProperties SignatureProperty SignatureValue SignedInfo SPKIData Transform Transforms	CanonicalizationMethodType DigestMethodType DSAKeyValueType KeyInfoType KeyValueType ManifestType ObjectType PGPDataType ReferenceType RetrievalMethodType RSAKeyValueType SignatureMethodType SignaturePropertiesType SignaturePropertyType SignatureType SignatureValueType SignedInfoType SPKIDataType TransformsType TransformType X509DataType X509IssuerSerialType	CryptoBinary DigestValueType HMACOutputLengthType

[X509Data](#)

element **FacturaElectronica**

diagram

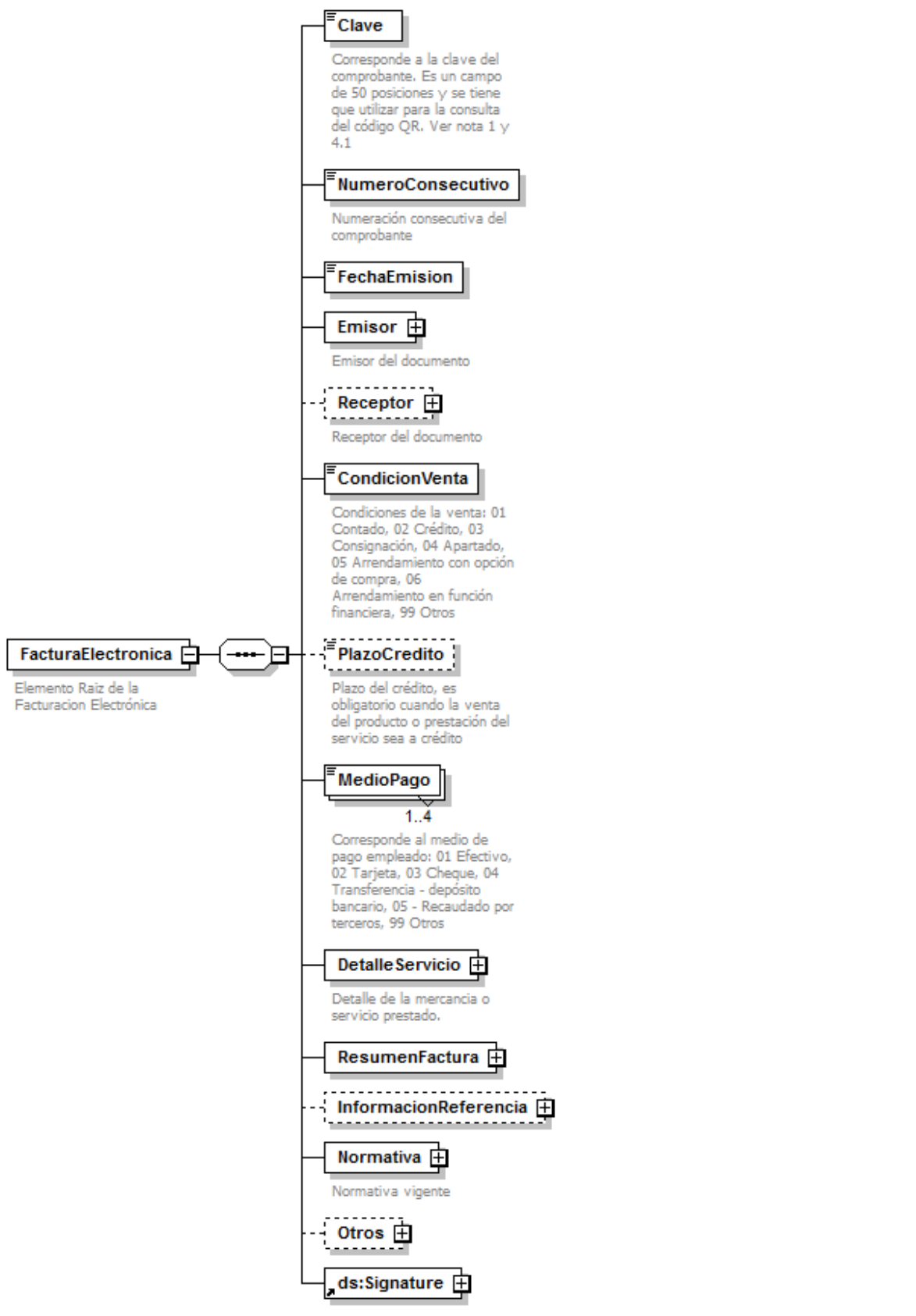

namespace	https://www.hacienda.go.cr/ATV/docs/esquemas/2016/v4/facturaElectronica
properties	content complex
children	Clave NumeroConsecutivo FechaEmision Emisor Receptor CondicionVenta PlazoCredito MedioPago DetalleServicio ResumenFactura InformacionReferencia Normativa Otros ds:Signature
annotation	documentation Elemento Raiz de la Facturacion Electrónica
source	<pre> <xs:element name="FacturaElectronica"> <xs:annotation> <xs:documentation>Elemento Raiz de la Facturacion Electrónica</xs:documentation> </xs:annotation> <xs:complexType> <xs:sequence> <xs:element name="Clave" type="ClaveType"> <xs:annotation> <xs:documentation>Corresponde a la clave del comprobante. Es un campo de 50 posiciones y se tiene que utilizar para la consulta del código QR. Ver nota 1 y 4.1</xs:documentation> </xs:annotation> </xs:element> <xs:element name="NumeroConsecutivo" type="NumeroConsecutivoType"> <xs:annotation> <xs:documentation>Numeración consecutiva del comprobante</xs:documentation> </xs:annotation> </xs:element> <xs:element name="FechaEmision" type="xs:dateTime"/> <xs:element name="Emisor" type="EmisorType"> <xs:annotation> <xs:documentation>Emisor del documento</xs:documentation> </xs:annotation> </xs:element> <xs:element name="Receptor" type="ReceptorType" minOccurs="0"> <xs:annotation> <xs:documentation>Receptor del documento</xs:documentation> </xs:annotation> </xs:element> <xs:element name="CondicionVenta"> <xs:annotation> <xs:documentation>Condiciones de la venta: 01 Contado, 02 Crédito, 03 Consignación, 04 Apartado, 05 Arrendamiento con opción de compra, 06 Arrendamiento en función financiera, 99 Otros</xs:documentation> </xs:annotation> <xs:simpleType> <xs:restriction base="xs:string"> <xs:enumeration value="01"> <xs:annotation> <xs:documentation>Contado</xs:documentation> </xs:annotation> </xs:enumeration> <xs:enumeration value="02"> <xs:annotation> <xs:documentation>Crédito</xs:documentation> </xs:annotation> </xs:enumeration> <xs:enumeration value="03"> <xs:annotation> </pre>

```

    <xs:documentation>Consignación</xs:documentation>
  </xs:annotation>
</xs:enumeration>
<xs:enumeration value="04">
  <xs:annotation>
    <xs:documentation>Apartado</xs:documentation>
  </xs:annotation>
</xs:enumeration>
<xs:enumeration value="05">
  <xs:annotation>
    <xs:documentation>Arrendamiento con opción de compra</xs:documentation>
  </xs:annotation>
</xs:enumeration>
<xs:enumeration value="06">
  <xs:annotation>
    <xs:documentation>Arrendamiento en función financiera</xs:documentation>
  </xs:annotation>
</xs:enumeration>
<xs:enumeration value="99">
  <xs:annotation>
    <xs:documentation>Otros</xs:documentation>
  </xs:annotation>
</xs:enumeration>
</xs:restriction>
</xs:simpleType>
</xs:element>
<xs:element name="PlazoCredito" minOccurs="0">
  <xs:annotation>
    <xs:documentation>Plazo del crédito, es obligatorio cuando la venta del producto o
prestación del servicio sea a crédito</xs:documentation>
  </xs:annotation>
  <xs:simpleType>
    <xs:restriction base="xs:string">
      <xs:maxLength value="10"/>
    </xs:restriction>
  </xs:simpleType>
</xs:element>
<xs:element name="MedioPago" maxOccurs="4">
  <xs:annotation>
    <xs:documentation>Corresponde al medio de pago empleado: 01 Efectivo, 02 Tarjeta, 03
Cheque, 04 Transferencia - depósito bancario, 05 - Recaudado por terceros, 99
Otros</xs:documentation>
  </xs:annotation>
  <xs:simpleType>
    <xs:restriction base="xs:string">
      <xs:enumeration value="01">
        <xs:annotation>
          <xs:documentation>Efectivo</xs:documentation>
        </xs:annotation>
      </xs:enumeration>
      <xs:enumeration value="02">
        <xs:annotation>
          <xs:documentation> Tarjeta</xs:documentation>
        </xs:annotation>
      </xs:enumeration>
      <xs:enumeration value="03">

```

```

    <xs:annotation>
      <xs:documentation>Cheque</xs:documentation>
    </xs:annotation>
  </xs:enumeration>
  <xs:enumeration value="04">
    <xs:annotation>
      <xs:documentation>Transferencia - depósito bancario</xs:documentation>
    </xs:annotation>
  </xs:enumeration>
  <xs:enumeration value="05">
    <xs:annotation>
      <xs:documentation>Recaudado por terceros</xs:documentation>
    </xs:annotation>
  </xs:enumeration>
  <xs:enumeration value="99">
    <xs:annotation>
      <xs:documentation>Otros</xs:documentation>
    </xs:annotation>
  </xs:enumeration>
</xs:restriction>
</xs:simpleType>
</xs:element>
<xs:element name="DetalleServicio">
  <xs:annotation>
    <xs:documentation>Detalle de la mercancía o servicio prestado.</xs:documentation>
  </xs:annotation>
  <xs:complexType>
    <xs:sequence>
      <xs:element name="LineaDetalle" maxOccurs="1000">
        <xs:annotation>
          <xs:documentation>Cada línea del detalle de la mercancía o servicio
prestado.</xs:documentation>
        </xs:annotation>
        <xs:complexType>
          <xs:sequence>
            <xs:element name="NumeroLinea" type="xs:positiveInteger">
              <xs:annotation>
                <xs:documentation>Número de línea del detalle</xs:documentation>
              </xs:annotation>
            </xs:element>
            <xs:element name="Codigo" type="CodigoType" minOccurs="0" maxOccurs="5"/>
            <xs:element name="Cantidad">
              <xs:annotation>
                <xs:documentation>Cantidad</xs:documentation>
              </xs:annotation>
              <xs:simpleType>
                <xs:restriction base="xs:integer">
                  <xs:totalDigits value="13"/>
                </xs:restriction>
              </xs:simpleType>
            </xs:element>
            <xs:element name="UnidadMedida" type="UnidadMedidaType">
              <xs:annotation>
                <xs:documentation>Unidad de medida </xs:documentation>
              </xs:annotation>
            </xs:element>
          </xs:sequence>
        </xs:complexType>
      </xs:element>
    </xs:sequence>
  </xs:complexType>
</xs:element>

```

```

<xs:element name="UnidadMedidaComercial" minOccurs="0">
  <xs:annotation>
    <xs:documentation>Unidad de medida comercial</xs:documentation>
  </xs:annotation>
  <xs:simpleType>
    <xs:restriction base="xs:string">
      <xs:maxLength value="20"/>
    </xs:restriction>
  </xs:simpleType>
</xs:element>
<xs:element name="Detalle">
  <xs:annotation>
    <xs:documentation>Detalle de la mercancia transferida o servicio
prestado</xs:documentation>
  </xs:annotation>
  <xs:simpleType>
    <xs:restriction base="xs:string">
      <xs:maxLength value="160"/>
    </xs:restriction>
  </xs:simpleType>
</xs:element>
<xs:element name="PrecioUnitario" type="DecimalDineroType">
  <xs:annotation>
    <xs:documentation>Precio Unitario</xs:documentation>
  </xs:annotation>
</xs:element>
<xs:element name="MontoTotal" type="DecimalDineroType">
  <xs:annotation>
    <xs:documentation>Se obtiene de multiplicar el campo cantidad por el campo precio
unitario</xs:documentation>
  </xs:annotation>
</xs:element>
<xs:element name="MontoDescuento" type="DecimalDineroType" minOccurs="0">
  <xs:annotation>
    <xs:documentation>Monto de descuento concedido, el cual es obligatorio si existe
descuento</xs:documentation>
  </xs:annotation>
</xs:element>
<xs:element name="NaturalezaDescuento" minOccurs="0">
  <xs:annotation>
    <xs:documentation>Naturaleza del descuento, que es obligatorio si existe
descuento</xs:documentation>
  </xs:annotation>
  <xs:simpleType>
    <xs:restriction base="xs:string">
      <xs:maxLength value="80"/>
    </xs:restriction>
  </xs:simpleType>
</xs:element>
<xs:element name="SubTotal" type="DecimalDineroType">
  <xs:annotation>
    <xs:documentation>Se obtiene de la resta del campo monto total menos monto de
descuento concedido</xs:documentation>
  </xs:annotation>
</xs:element>
<xs:element name="Exoneracion" type="ExoneracionType" minOccurs="0">

```

```

        <xs:annotation>
          <xs:documentation>Elemento para el detalle de la exoneración, si es
requerido</xs:documentation>
        </xs:annotation>
      </xs:element>
      <xs:element name="Impuesto" type="ImpuestoType" minOccurs="0"
maxOccurs="unbounded">
        <xs:annotation>
          <xs:documentation>Cuando el producto o servicio este gravado con algún impuesto
se debe indicar cada uno de ellos.</xs:documentation>
        </xs:annotation>
      </xs:element>
      <xs:element name="MontoTotalLinea" type="DecimalDineroType">
        <xs:annotation>
          <xs:documentation>Se obtiene de la suma de los campos subtotal más monto de los
impuestos</xs:documentation>
        </xs:annotation>
      </xs:element>
    </xs:sequence>
  </xs:complexType>
</xs:element>
<xs:element name="ResumenFactura">
  <xs:complexType>
    <xs:sequence>
      <xs:element name="CodigoMoneda" minOccurs="0">
        <xs:annotation>
          <xs:documentation>Código de la moneda de acuerdo al ISO 4217</xs:documentation>
        </xs:annotation>
        <xs:simpleType>
          <xs:restriction base="xs:string">
            <xs:enumeration value="AED"/>
            <xs:enumeration value="AFN"/>
            <xs:enumeration value="ALL"/>
            <xs:enumeration value="AMD"/>
            <xs:enumeration value="ANG"/>
            <xs:enumeration value="AOA"/>
            <xs:enumeration value="ARS"/>
            <xs:enumeration value="AUD"/>
            <xs:enumeration value="AWG"/>
            <xs:enumeration value="AZN"/>
            <xs:enumeration value="BAM"/>
            <xs:enumeration value="BBD"/>
            <xs:enumeration value="BDT"/>
            <xs:enumeration value="BGN"/>
            <xs:enumeration value="BHD"/>
            <xs:enumeration value="BIF"/>
            <xs:enumeration value="BMD"/>
            <xs:enumeration value="BND"/>
            <xs:enumeration value="BOB"/>
            <xs:enumeration value="BOV"/>
            <xs:enumeration value="BRL"/>
            <xs:enumeration value="BSD"/>
            <xs:enumeration value="BTN"/>
          </xs:restriction>
        </xs:simpleType>
      </xs:element>
    </xs:sequence>
  </xs:complexType>
</xs:element>

```

<xs:enumeration value="BWP"/>
<xs:enumeration value="BYR"/>
<xs:enumeration value="BZD"/>
<xs:enumeration value="CAD"/>
<xs:enumeration value="CDF"/>
<xs:enumeration value="CHE"/>
<xs:enumeration value="CHF"/>
<xs:enumeration value="CHW"/>
<xs:enumeration value="CLF"/>
<xs:enumeration value="CLP"/>
<xs:enumeration value="CNY"/>
<xs:enumeration value="COP"/>
<xs:enumeration value="COU"/>
<xs:enumeration value="CRC"/>
<xs:enumeration value="CUC"/>
<xs:enumeration value="CUP"/>
<xs:enumeration value="CVE"/>
<xs:enumeration value="CZK"/>
<xs:enumeration value="DJF"/>
<xs:enumeration value="DKK"/>
<xs:enumeration value="DOP"/>
<xs:enumeration value="DZD"/>
<xs:enumeration value="EGP"/>
<xs:enumeration value="ERN"/>
<xs:enumeration value="ETB"/>
<xs:enumeration value="EUR"/>
<xs:enumeration value="FJD"/>
<xs:enumeration value="FKP"/>
<xs:enumeration value="GBP"/>
<xs:enumeration value="GEL"/>
<xs:enumeration value="GHS"/>
<xs:enumeration value="GIP"/>
<xs:enumeration value="GMD"/>
<xs:enumeration value="GNF"/>
<xs:enumeration value="GTQ"/>
<xs:enumeration value="GYD"/>
<xs:enumeration value="HKD"/>
<xs:enumeration value="HNL"/>
<xs:enumeration value="HRK"/>
<xs:enumeration value="HTG"/>
<xs:enumeration value="HUF"/>
<xs:enumeration value="IDR"/>
<xs:enumeration value="ILS"/>
<xs:enumeration value="INR"/>
<xs:enumeration value="IQD"/>
<xs:enumeration value="IRR"/>
<xs:enumeration value="ISK"/>
<xs:enumeration value="JMD"/>
<xs:enumeration value="JOD"/>
<xs:enumeration value="JPY"/>
<xs:enumeration value="KES"/>
<xs:enumeration value="KGS"/>
<xs:enumeration value="KHR"/>
<xs:enumeration value="KMF"/>
<xs:enumeration value="KPW"/>
<xs:enumeration value="KRW"/>

<xs:enumeration value="KWD"/>
<xs:enumeration value="KYD"/>
<xs:enumeration value="KZT"/>
<xs:enumeration value="LAK"/>
<xs:enumeration value="LBP"/>
<xs:enumeration value="LKR"/>
<xs:enumeration value="LRD"/>
<xs:enumeration value="LSL"/>
<xs:enumeration value="LYD"/>
<xs:enumeration value="MAD"/>
<xs:enumeration value="MDL"/>
<xs:enumeration value="MGA"/>
<xs:enumeration value="MKD"/>
<xs:enumeration value="MMK"/>
<xs:enumeration value="MNT"/>
<xs:enumeration value="MOP"/>
<xs:enumeration value="MRO"/>
<xs:enumeration value="MUR"/>
<xs:enumeration value="MVR"/>
<xs:enumeration value="MWK"/>
<xs:enumeration value="MXN"/>
<xs:enumeration value="MXV"/>
<xs:enumeration value="MYR"/>
<xs:enumeration value="MZN"/>
<xs:enumeration value="NAD"/>
<xs:enumeration value="NGN"/>
<xs:enumeration value="NIO"/>
<xs:enumeration value="NOK"/>
<xs:enumeration value="NPR"/>
<xs:enumeration value="NZD"/>
<xs:enumeration value="OMR"/>
<xs:enumeration value="PAB"/>
<xs:enumeration value="PEN"/>
<xs:enumeration value="PGK"/>
<xs:enumeration value="PHP"/>
<xs:enumeration value="PKR"/>
<xs:enumeration value="PLN"/>
<xs:enumeration value="PYG"/>
<xs:enumeration value="QAR"/>
<xs:enumeration value="RON"/>
<xs:enumeration value="RSD"/>
<xs:enumeration value="RUB"/>
<xs:enumeration value="RWF"/>
<xs:enumeration value="SAR"/>
<xs:enumeration value="SBD"/>
<xs:enumeration value="SCR"/>
<xs:enumeration value="SDG"/>
<xs:enumeration value="SEK"/>
<xs:enumeration value="SGD"/>
<xs:enumeration value="SHP"/>
<xs:enumeration value="SLL"/>
<xs:enumeration value="SOS"/>
<xs:enumeration value="SRD"/>
<xs:enumeration value="SSP"/>
<xs:enumeration value="STD"/>
<xs:enumeration value="SVC"/>

```
<xs:enumeration value="SYP"/>
<xs:enumeration value="SZL"/>
<xs:enumeration value="THB"/>
<xs:enumeration value="TJS"/>
<xs:enumeration value="TMT"/>
<xs:enumeration value="TND"/>
<xs:enumeration value="TOP"/>
<xs:enumeration value="TRY"/>
<xs:enumeration value="TTD"/>
<xs:enumeration value="TWD"/>
<xs:enumeration value="TZS"/>
<xs:enumeration value="UAH"/>
<xs:enumeration value="UGX"/>
<xs:enumeration value="USD"/>
<xs:enumeration value="USN"/>
<xs:enumeration value="UYI"/>
<xs:enumeration value="UYU"/>
<xs:enumeration value="UZS"/>
<xs:enumeration value="VEF"/>
<xs:enumeration value="VND"/>
<xs:enumeration value="VUV"/>
<xs:enumeration value="WST"/>
<xs:enumeration value="XAF"/>
<xs:enumeration value="XAG"/>
<xs:enumeration value="XAU"/>
<xs:enumeration value="XBA"/>
<xs:enumeration value="XBB"/>
<xs:enumeration value="XBC"/>
<xs:enumeration value="XBD"/>
<xs:enumeration value="XCD"/>
<xs:enumeration value="XDR"/>
<xs:enumeration value="XOF"/>
<xs:enumeration value="XPD"/>
<xs:enumeration value="XPF"/>
<xs:enumeration value="XPT"/>
<xs:enumeration value="XSU"/>
<xs:enumeration value="XTS"/>
<xs:enumeration value="XUA"/>
<xs:enumeration value="XXX"/>
<xs:enumeration value="YER"/>
<xs:enumeration value="ZAR"/>
<xs:enumeration value="ZMW"/>
<xs:enumeration value="ZWL"/>
</xs:restriction>
</xs:simpleType>
</xs:element>
<xs:element name="TipoCambio" type="DecimalDineroType" minOccurs="0">
  <xs:annotation>
    <xs:documentation>Tipo de cambio</xs:documentation>
  </xs:annotation>
</xs:element>
<xs:element name="TotalServGravados" type="DecimalDineroType" minOccurs="0">
  <xs:annotation>
    <xs:documentation>Total de los servicios gravados con IV</xs:documentation>
  </xs:annotation>
</xs:element>
```

```

<xs:element name="TotalServExentos" type="DecimalDineroType" minOccurs="0">
  <xs:annotation>
    <xs:documentation>Total de los servicios exentos de IV</xs:documentation>
  </xs:annotation>
</xs:element>
<xs:element name="TotalMercanciasGravadas" type="DecimalDineroType"
minOccurs="0">
  <xs:annotation>
    <xs:documentation>Total mercancias gravadas con IV</xs:documentation>
  </xs:annotation>
</xs:element>
<xs:element name="TotalMercanciasExentas" type="DecimalDineroType" minOccurs="0">
  <xs:annotation>
    <xs:documentation>Total mercancias exentas de IV</xs:documentation>
  </xs:annotation>
</xs:element>
<xs:element name="TotalGravado" type="DecimalDineroType" minOccurs="0">
  <xs:annotation>
    <xs:documentation>Total gravado. se obtiene de la suma del total servicios gravados
con IV + total mercancias gravadas con IV</xs:documentation>
  </xs:annotation>
</xs:element>
<xs:element name="TotalExento" type="DecimalDineroType" minOccurs="0">
  <xs:annotation>
    <xs:documentation>Total Exento, se obtiene de la suma de los campos total servicios
exentos IV mas total mercancias exentas IV</xs:documentation>
  </xs:annotation>
</xs:element>
<xs:element name="TotalVenta" type="DecimalDineroType">
  <xs:annotation>
    <xs:documentation>Se obtiene de la suma de los campos total gravado más total
exento</xs:documentation>
  </xs:annotation>
</xs:element>
<xs:element name="TotalDescuentos" type="DecimalDineroType" minOccurs="0">
  <xs:annotation>
    <xs:documentation>Se obtiene de la suma de todos los campo de monto de descuento
concedido</xs:documentation>
  </xs:annotation>
</xs:element>
<xs:element name="TotalVentaNeta" type="DecimalDineroType">
  <xs:annotation>
    <xs:documentation>Se obtiene de la resta de los campos total venta menos total
descuento</xs:documentation>
  </xs:annotation>
</xs:element>
<xs:element name="TotalImpuesto" type="ImpuestoType" minOccurs="0"
maxOccurs="unbounded">
  <xs:annotation>
    <xs:documentation>Se obtiene de la suma de todos campos monto del
impuesto</xs:documentation>
  </xs:annotation>
</xs:element>
<xs:element name="TotalComprobante" type="DecimalDineroType">
  <xs:annotation>
    <xs:documentation>Se obtiene de la suma de los campos total venta neta más monto

```

```

total de los impuestos</xs:documentation>
  </xs:annotation>
</xs:element>
</xs:sequence>
</xs:complexType>
</xs:element>
<xs:element name="InformacionReferencia" minOccurs="0">
  <xs:complexType>
    <xs:sequence>
      <xs:element name="TipoDoc">
        <xs:annotation>
          <xs:documentation>Tipo de documento de referencia. 01 Factura electrónica, 02 Nota
de débito electrónica, 03 nota de crédito electrónica, 04 Tiquete electrónico, 05 Nota de despacho,
06 Contrato, 07 Procedimiento, 08 Comprobante emitido en contingencia, 99
Otros</xs:documentation>
        </xs:annotation>
<xs:simpleType>
  <xs:restriction base="xs:string">
    <xs:enumeration value="01">
      <xs:annotation>
        <xs:documentation>Factura electrónica</xs:documentation>
      </xs:annotation>
    </xs:enumeration>
    <xs:enumeration value="02">
      <xs:annotation>
        <xs:documentation>Nota de debito electrónica</xs:documentation>
      </xs:annotation>
    </xs:enumeration>
    <xs:enumeration value="03">
      <xs:annotation>
        <xs:documentation>nota de crédito electrónica</xs:documentation>
      </xs:annotation>
    </xs:enumeration>
    <xs:enumeration value="04">
      <xs:annotation>
        <xs:documentation>Tiquete electrónico</xs:documentation>
      </xs:annotation>
    </xs:enumeration>
    <xs:enumeration value="05">
      <xs:annotation>
        <xs:documentation>Nota de despacho</xs:documentation>
      </xs:annotation>
    </xs:enumeration>
    <xs:enumeration value="06">
      <xs:annotation>
        <xs:documentation>Contrato</xs:documentation>
      </xs:annotation>
    </xs:enumeration>
    <xs:enumeration value="07">
      <xs:annotation>
        <xs:documentation>Procedimiento</xs:documentation>
      </xs:annotation>
    </xs:enumeration>
    <xs:enumeration value="08">
      <xs:annotation>
        <xs:documentation>Comprobante emitido en contingencia</xs:documentation>
      </xs:annotation>
    </xs:enumeration>
  </xs:restriction>

```

```

</xs:annotation>
</xs:enumeration>
<xs:enumeration value="99">
  <xs:annotation>
    <xs:documentation>Otros</xs:documentation>
  </xs:annotation>
</xs:enumeration>
</xs:restriction>
</xs:simpleType>
</xs:element>
<xs:element name="Numero">
  <xs:annotation>
    <xs:documentation>Número de documento de referencia</xs:documentation>
  </xs:annotation>
  <xs:simpleType>
    <xs:restriction base="xs:string">
      <xs:maxLength value="50"/>
    </xs:restriction>
  </xs:simpleType>
</xs:element>
<xs:element name="FechaEmision" type="xs:dateTime">
  <xs:annotation>
    <xs:documentation>Fecha y hora de emisión del documento de
referencia</xs:documentation>
  </xs:annotation>
</xs:element>
<xs:element name="Codigo">
  <xs:annotation>
    <xs:documentation>Código de referencia. 01 Anula documento de referencia, 02 Corrige
texto de documento de referencia, 03 Corrige monto, 04 Referencia a otro documento, 05
Sustituye comprobante provisional por contingencia, 99 Otros</xs:documentation>
  </xs:annotation>
  <xs:simpleType>
    <xs:restriction base="xs:string">
      <xs:enumeration value="01">
        <xs:annotation>
          <xs:documentation>Anula documento de referencia</xs:documentation>
        </xs:annotation>
      </xs:enumeration>
      <xs:enumeration value="02">
        <xs:annotation>
          <xs:documentation>Corrige texto de ocumento de referencia</xs:documentation>
        </xs:annotation>
      </xs:enumeration>
      <xs:enumeration value="03">
        <xs:annotation>
          <xs:documentation>Corrige monto</xs:documentation>
        </xs:annotation>
      </xs:enumeration>
      <xs:enumeration value="04">
        <xs:annotation>
          <xs:documentation>Referencia a otro documento</xs:documentation>
        </xs:annotation>
      </xs:enumeration>
      <xs:enumeration value="05">
        <xs:annotation>

```

```

        <xs:documentation>Sustituye comprobante provisional por
contingencia</xs:documentation>
        </xs:annotation>
        </xs:enumeration>
        <xs:enumeration value="99">
        <xs:annotation>
        <xs:documentation>Otros</xs:documentation>
        </xs:annotation>
        </xs:enumeration>
        </xs:restriction>
        </xs:simpleType>
    </xs:element>
    <xs:element name="Razon">
    <xs:annotation>
    <xs:documentation>Razón de referencia</xs:documentation>
    </xs:annotation>
    <xs:simpleType>
    <xs:restriction base="xs:string">
    <xs:maxLength value="180"/>
    </xs:restriction>
    </xs:simpleType>
    </xs:element>
</xs:sequence>
</xs:complexType>
</xs:element>
<xs:element name="Normativa">
<xs:annotation>
<xs:documentation>Normativa vigente</xs:documentation>
</xs:annotation>
<xs:complexType>
<xs:sequence>
<xs:element name="NumeroResolucion">
<xs:annotation>
<xs:documentation>Se debe indicar el número de resolución DGT
XXXX</xs:documentation>
</xs:annotation>
<xs:simpleType>
<xs:restriction base="xs:string">
<xs:maxLength value="13"/>
</xs:restriction>
</xs:simpleType>
</xs:element>
<xs:element name="FechaResolucion">
<xs:annotation>
<xs:documentation>La fecha y hora de resolución. DD-MM-YYYY
HH:MM:SS</xs:documentation>
</xs:annotation>
<xs:simpleType>
<xs:restriction base="xs:string">
<xs:maxLength value="20"/>
</xs:restriction>
</xs:simpleType>
</xs:element>
</xs:sequence>
</xs:complexType>
</xs:element>

```

```

<xs:element name="Otros" minOccurs="0">
  <xs:complexType>
    <xs:sequence>
      <xs:element name="OtroTexto" minOccurs="0" maxOccurs="unbounded">
        <xs:annotation>
          <xs:documentation>Elemento opcional que se puede utilizar la almacenar
texto.</xs:documentation>
        </xs:annotation>
      <xs:complexType>
        <xs:simpleContent>
          <xs:extension base="xs:string">
            <xs:attribute name="codigo" type="xs:string">
              <xs:annotation>
                <xs:documentation>Código opcional para facilitar la identificación del
elemento.</xs:documentation>
              </xs:annotation>
            </xs:attribute>
          </xs:extension>
        </xs:simpleContent>
      </xs:complexType>
    </xs:element>
    <xs:element name="OtroContenido" minOccurs="0" maxOccurs="unbounded">
      <xs:annotation>
        <xs:documentation>Elemento opcional que se puede utilizar para almacenar contenido
estructurado.</xs:documentation>
      </xs:annotation>
      <xs:complexType>
        <xs:sequence>
          <xs:any namespace="##other" processContents="lax"/>
        </xs:sequence>
        <xs:attribute name="codigo" type="xs:string">
          <xs:annotation>
            <xs:documentation>Código opcional para facilitar la identificación del
elemento.</xs:documentation>
          </xs:annotation>
        </xs:attribute>
      </xs:complexType>
    </xs:element>
  </xs:sequence>
</xs:complexType>
</xs:element>

```

element **FacturaElectronica/Clave**

diagram

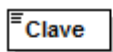

Corresponde a la clave del comprobante. Es un campo de 50 posiciones y se tiene que utilizar para la consulta del código QR. Ver nota 1 y 4.1

namespace	https://www.hacienda.go.cr/ATV/docs/esquemas/2016/v4/facturaElectronica						
type	ClaveType						
properties	content simple						
facets	<table border="1"> <thead> <tr> <th>Kind</th> <th>Value</th> <th>Annotation</th> </tr> </thead> <tbody> <tr> <td>pattern</td> <td>\d{50,50}</td> <td></td> </tr> </tbody> </table>	Kind	Value	Annotation	pattern	\d{50,50}	
Kind	Value	Annotation					
pattern	\d{50,50}						
annotation	<p>documentation</p> <p>Corresponde a la clave del comprobante. Es un campo de 50 posiciones y se tiene que utilizar para la consulta del código QR. Ver nota 1 y 4.1</p>						
source	<pre><xs:element name="Clave" type="ClaveType"> <xs:annotation> <xs:documentation>Corresponde a la clave del comprobante. Es un campo de 50 posiciones y se tiene que utilizar para la consulta del código QR. Ver nota 1 y 4.1</xs:documentation> </xs:annotation> </xs:element></pre>						

element FacturaElectronica/NumeroConsecutivo

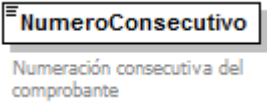
diagram							
namespace	https://www.hacienda.go.cr/ATV/docs/esquemas/2016/v4/facturaElectronica						
type	NumeroConsecutivoType						
properties	content simple						
facets	<table border="1"> <thead> <tr> <th>Kind</th> <th>Value</th> <th>Annotation</th> </tr> </thead> <tbody> <tr> <td>pattern</td> <td>\d{20,20}</td> <td></td> </tr> </tbody> </table>	Kind	Value	Annotation	pattern	\d{20,20}	
Kind	Value	Annotation					
pattern	\d{20,20}						
annotation	<p>documentation</p> <p>Numeración consecutiva del comprobante</p>						
source	<pre><xs:element name="NumeroConsecutivo" type="NumeroConsecutivoType"> <xs:annotation> <xs:documentation>Numeración consecutiva del comprobante</xs:documentation> </xs:annotation> </xs:element></pre>						

element FacturaElectronica/FechaEmision

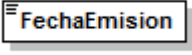
diagram	
namespace	https://www.hacienda.go.cr/ATV/docs/esquemas/2016/v4/facturaElectronica
type	xs:dateTime
properties	content simple
source	<pre><xs:element name="FechaEmision" type="xs:dateTime"/></pre>

element **FacturaElectronica/Emisor**

<p>diagram</p>	
<p>namespace</p>	<p>https://www.hacienda.go.cr/ATV/docs/esquemas/2016/v4/facturaElectronica</p>
<p>type</p>	<p>EmisorType</p>
<p>properties</p>	<p>content complex</p>
<p>children</p>	<p>Nombre Identificacion NombreComercial Ubicacion Telefono Fax CorreoElectronico</p>
<p>annotation</p>	<p>documentation Emisor del documento</p>
<p>source</p>	<pre><xs:element name="Emisor" type="EmisorType"> <xs:annotation> <xs:documentation>Emisor del documento</xs:documentation> </xs:annotation> </xs:element></pre>

element **FacturaElectronica/Receptor**

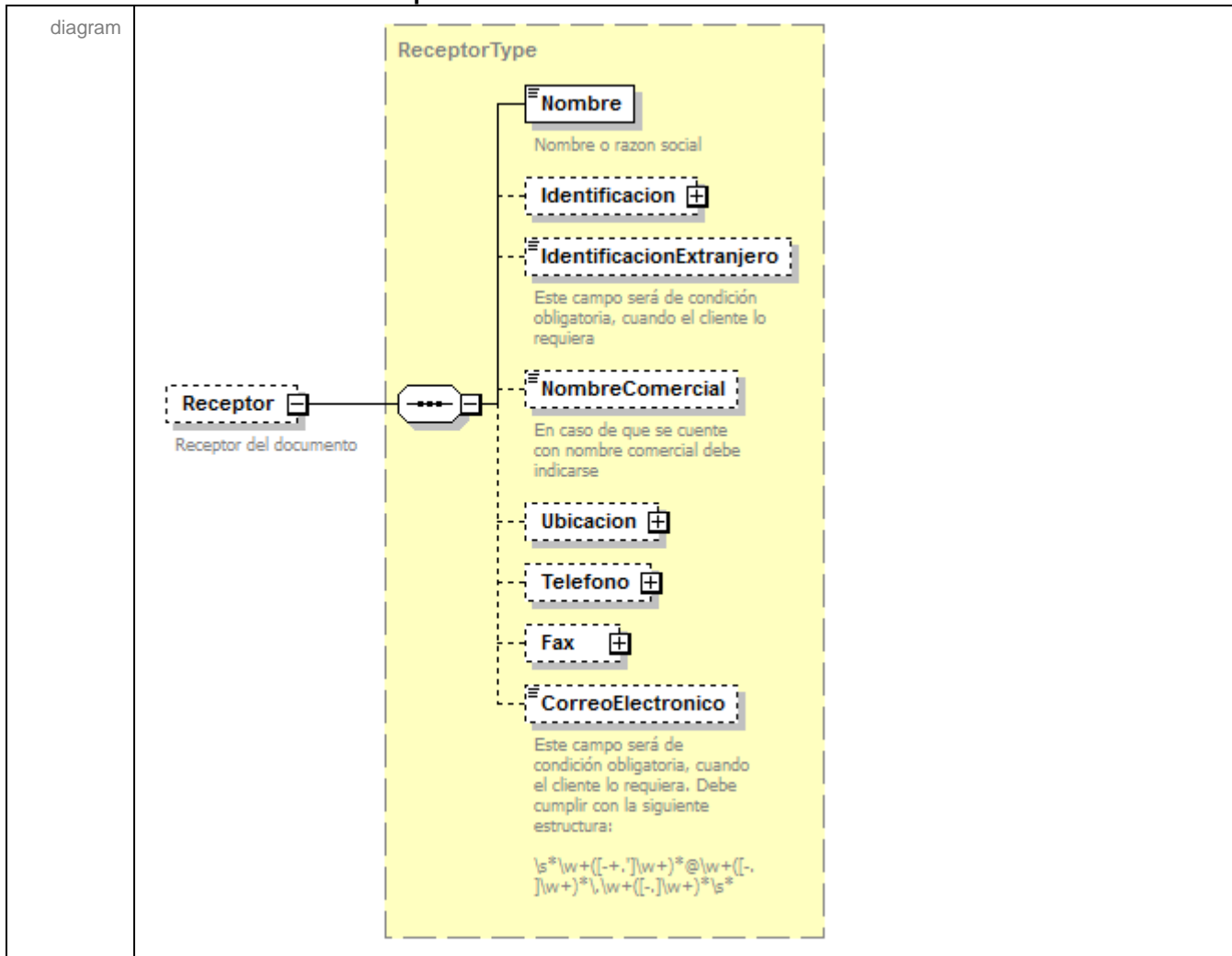

namespace	</facturaElectronica
type	ReceptorType
properties	minOcc 0 maxOcc 1 content complex
children	Nombre Identificacion IdentificacionExtranjero NombreComercial Ubicacion Telefono Fax CorreoElectronico
annotation	documentation Receptor del documento
source	<xs:element name="Receptor" type="ReceptorType" minOccurs="0"> <xs:annotation> <xs:documentation>Receptor del documento</xs:documentation> </xs:annotation> </xs:element>

element **FacturaElectronica/CondicionVenta**

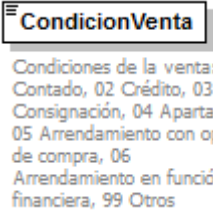
diagram	 <p>CondicionVenta</p> <p>Condiciones de la venta: 01 Contado, 02 Crédito, 03 Consignación, 04 Apartado, 05 Arrendamiento con opción de compra, 06 Arrendamiento en función financiera, 99 Otros</p>																								
namespace	https://www.hacienda.go.cr/ATV/docs/esquemas/2016/v4/facturaElectronica																								
type	restriction of xs:string																								
properties	content simple																								
facets	<table border="1"> <thead> <tr> <th>Kind</th> <th>Value</th> <th>Annotation</th> </tr> </thead> <tbody> <tr> <td>enumeration</td> <td>01</td> <td>documentation Contado</td> </tr> <tr> <td>enumeration</td> <td>02</td> <td>documentation Crédito</td> </tr> <tr> <td>enumeration</td> <td>03</td> <td>documentation Consignación</td> </tr> <tr> <td>enumeration</td> <td>04</td> <td>documentation Apartado</td> </tr> <tr> <td>enumeration</td> <td>05</td> <td>documentation Arrendamiento con opción de compra</td> </tr> <tr> <td>enumeration</td> <td>06</td> <td>documentation Arrendamiento en función financiera</td> </tr> <tr> <td>enumeration</td> <td>99</td> <td>documentation Otros</td> </tr> </tbody> </table>	Kind	Value	Annotation	enumeration	01	documentation Contado	enumeration	02	documentation Crédito	enumeration	03	documentation Consignación	enumeration	04	documentation Apartado	enumeration	05	documentation Arrendamiento con opción de compra	enumeration	06	documentation Arrendamiento en función financiera	enumeration	99	documentation Otros
Kind	Value	Annotation																							
enumeration	01	documentation Contado																							
enumeration	02	documentation Crédito																							
enumeration	03	documentation Consignación																							
enumeration	04	documentation Apartado																							
enumeration	05	documentation Arrendamiento con opción de compra																							
enumeration	06	documentation Arrendamiento en función financiera																							
enumeration	99	documentation Otros																							
annotation	documentation Condiciones de la venta: 01 Contado, 02 Crédito, 03 Consignación, 04 Apartado, 05 Arrendamiento con opción de compra, 06 Arrendamiento en función financiera, 99 Otros																								
source	<pre> <xs:element name="CondicionVenta"> <xs:annotation> <xs:documentation>Condiciones de la venta: 01 Contado, 02 Crédito, 03 Consignación, 04 Apartado, 05 Arrendamiento con opción de compra, 06 Arrendamiento en función financiera, 99 Otros</xs:documentation> </xs:annotation> <xs:simpleType> <xs:restriction base="xs:string"> <xs:enumeration value="01"> <xs:annotation> <xs:documentation>Contado</xs:documentation> </xs:annotation> </xs:enumeration> <xs:enumeration value="02"> <xs:annotation> <xs:documentation>Crédito</xs:documentation> </xs:annotation> </xs:enumeration> <xs:enumeration value="03"> <xs:annotation> <xs:documentation>Consignación</xs:documentation> </xs:annotation> </xs:enumeration> <xs:enumeration value="04"> <xs:annotation> <xs:documentation>Apartado</xs:documentation> </xs:annotation> </xs:enumeration> </xs:restriction> </xs:simpleType> </xs:element> </pre>																								

	<pre> </xs:enumeration> <xs:enumeration value="05"> <xs:annotation> <xs:documentation>Arrendamiento con opción de compra</xs:documentation> </xs:annotation> </xs:enumeration> <xs:enumeration value="06"> <xs:annotation> <xs:documentation>Arrendamiento en función financiera</xs:documentation> </xs:annotation> </xs:enumeration> <xs:enumeration value="99"> <xs:annotation> <xs:documentation>Otros</xs:documentation> </xs:annotation> </xs:enumeration> </xs:restriction> </xs:simpleType> </xs:element> </pre>
--	--------------------------------------------------------------------------------------------------------------------------------------------------------------------------------------------------------------------------------------------------------------------------------------------------------------------------------------------------------------------------------------------------------------------------------------------------------------------------------------------------------------------------------------------------------------------------------------------------------------------------------------------------------------------------------------

element **FacturaElectronica/PlazoCredito**

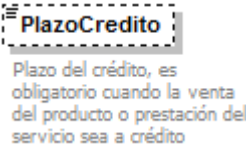
diagram	 <p>Plazo del crédito, es obligatorio cuando la venta del producto o prestación del servicio sea a crédito</p>
namespace	https://www.hacienda.go.cr/ATV/docs/esquemas/2016/v4/facturaElectronica
type	restriction of xs:string
properties	minOcc 0 maxOcc 1 content simple
facets	Kind Value Annotation maxLength 10
annotation	documentation Plazo del crédito, es obligatorio cuando la venta del producto o prestación del servicio sea a crédito
source	<pre> <xs:element name="PlazoCredito" minOccurs="0"> <xs:annotation> <xs:documentation>Plazo del crédito, es obligatorio cuando la venta del producto o prestación del servicio sea a crédito</xs:documentation> </xs:annotation> <xs:simpleType> <xs:restriction base="xs:string"> <xs:maxLength value="10"/> </xs:restriction> </xs:simpleType> </xs:element> </pre>

element **FacturaElectronica/MedioPago**

<p>diagram</p>	 <p>1..4</p> <p>Corresponde al medio de pago empleado: 01 Efectivo, 02 Tarjeta, 03 Cheque, 04 Transferencia - depósito bancario, 05 - Recaudado por terceros, 99 Otros</p>																					
<p>namespace</p>	<p>https://www.hacienda.go.cr/ATV/docs/esquemas/2016/v4/facturaElectronica</p>																					
<p>type</p>	<p>restriction of xs:string</p>																					
<p>properties</p>	<p>minOcc 1 maxOcc 4 content simple</p>																					
<p>facets</p>	<table border="1"> <thead> <tr> <th>Kind</th> <th>Value</th> <th>Annotation</th> </tr> </thead> <tbody> <tr> <td>enumeration</td> <td>01</td> <td>documentation Efectivo</td> </tr> <tr> <td>enumeration</td> <td>02</td> <td>documentation Tarjeta</td> </tr> <tr> <td>enumeration</td> <td>03</td> <td>documentation Cheque</td> </tr> <tr> <td>enumeration</td> <td>04</td> <td>documentation Transferencia - depósito bancario</td> </tr> <tr> <td>enumeration</td> <td>05</td> <td>documentation Recaudado por terceros</td> </tr> <tr> <td>enumeration</td> <td>99</td> <td>documentation Otros</td> </tr> </tbody> </table>	Kind	Value	Annotation	enumeration	01	documentation Efectivo	enumeration	02	documentation Tarjeta	enumeration	03	documentation Cheque	enumeration	04	documentation Transferencia - depósito bancario	enumeration	05	documentation Recaudado por terceros	enumeration	99	documentation Otros
Kind	Value	Annotation																				
enumeration	01	documentation Efectivo																				
enumeration	02	documentation Tarjeta																				
enumeration	03	documentation Cheque																				
enumeration	04	documentation Transferencia - depósito bancario																				
enumeration	05	documentation Recaudado por terceros																				
enumeration	99	documentation Otros																				
<p>annotation</p>	<p>documentation Corresponde al medio de pago empleado: 01 Efectivo, 02 Tarjeta, 03 Cheque, 04 Transferencia - depósito bancario, 05 - Recaudado por terceros, 99 Otros</p>																					
<p>source</p>	<pre> <xs:element name="MedioPago" maxOccurs="4"> <xs:annotation> <xs:documentation>Corresponde al medio de pago empleado: 01 Efectivo, 02 Tarjeta, 03 Cheque, 04 Transferencia - depósito bancario, 05 - Recaudado por terceros, 99 Otros</xs:documentation> </xs:annotation> <xs:simpleType> <xs:restriction base="xs:string"> <xs:enumeration value="01"> <xs:annotation> <xs:documentation>Efectivo</xs:documentation> </xs:annotation> </xs:enumeration> <xs:enumeration value="02"> <xs:annotation> <xs:documentation> Tarjeta</xs:documentation> </xs:annotation> </xs:enumeration> <xs:enumeration value="03"> <xs:annotation> <xs:documentation>Cheque</xs:documentation> </xs:annotation> </xs:enumeration> <xs:enumeration value="04"> <xs:annotation> <xs:documentation>Transferencia - depósito bancario</xs:documentation> </xs:annotation> </xs:enumeration> <xs:enumeration value="99"> <xs:annotation> <xs:documentation>Otros</xs:documentation> </xs:annotation> </xs:enumeration> </xs:restriction> </xs:simpleType> </xs:element> </pre>																					

<pre> <xs:enumeration value="05"> <xs:annotation> <xs:documentation>Recaudado por terceros</xs:documentation> </xs:annotation> </xs:enumeration> <xs:enumeration value="99"> <xs:annotation> <xs:documentation>Otros</xs:documentation> </xs:annotation> </xs:enumeration> </xs:restriction> </xs:simpleType> </xs:element> </pre>

element **FacturaElectronica/DetalleServicio**

diagram	<pre> classDiagram class DetalleServicio { "Detalle de la mercancia o servicio prestado." } class LineaDetalle { "Cada línea del detalle de la mercancia o servicio prestado." } DetalleServicio "1" -- "1..1000" LineaDetalle </pre>
namespace	https://www.hacienda.go.cr/ATV/docs/esquemas/2016/v4/facturaElectronica
properties	content complex
children	LineaDetalle
annotation	documentation Detalle de la mercancia o servicio prestado.
source	<pre> <xs:element name="DetalleServicio"> <xs:annotation> <xs:documentation>Detalle de la mercancia o servicio prestado.</xs:documentation> </xs:annotation> <xs:complexType> <xs:sequence> <xs:element name="LineaDetalle" maxOccurs="1000"> <xs:annotation> <xs:documentation>Cada línea del detalle de la mercancia o servicio prestado.</xs:documentation> </xs:annotation> <xs:complexType> <xs:sequence> <xs:element name="NumeroLinea" type="xs:positiveInteger"> <xs:annotation> <xs:documentation>Número de línea del detalle</xs:documentation> </xs:annotation> </xs:element> <xs:element name="Codigo" type="CodigoType" minOccurs="0" maxOccurs="5"/> <xs:element name="Cantidad"> <xs:annotation> <xs:documentation>Cantidad</xs:documentation> </xs:annotation> <xs:simpleType> <xs:restriction base="xs:integer"> <xs:totalDigits value="13"/> </xs:restriction> </xs:simpleType> </xs:sequence> </xs:complexType> </xs:element> </xs:sequence> </xs:complexType> </xs:element> </pre>

```

</xs:restriction>
</xs:simpleType>
</xs:element>
<xs:element name="UnidadMedida" type="UnidadMedidaType">
  <xs:annotation>
    <xs:documentation>Unidad de medida </xs:documentation>
  </xs:annotation>
</xs:element>
<xs:element name="UnidadMedidaComercial" minOccurs="0">
  <xs:annotation>
    <xs:documentation>Unidad de medida comercial</xs:documentation>
  </xs:annotation>
  <xs:simpleType>
    <xs:restriction base="xs:string">
      <xs:maxLength value="20"/>
    </xs:restriction>
  </xs:simpleType>
</xs:element>
<xs:element name="Detalle">
  <xs:annotation>
    <xs:documentation>Detalle de la mercancia transferida o servicio
prestado</xs:documentation>
  </xs:annotation>
  <xs:simpleType>
    <xs:restriction base="xs:string">
      <xs:maxLength value="160"/>
    </xs:restriction>
  </xs:simpleType>
</xs:element>
<xs:element name="PrecioUnitario" type="DecimalDineroType">
  <xs:annotation>
    <xs:documentation>Precio Unitario</xs:documentation>
  </xs:annotation>
</xs:element>
<xs:element name="MontoTotal" type="DecimalDineroType">
  <xs:annotation>
    <xs:documentation>Se obtiene de multiplicar el campo cantidad por el campo precio
unitario</xs:documentation>
  </xs:annotation>
</xs:element>
<xs:element name="MontoDescuento" type="DecimalDineroType" minOccurs="0">
  <xs:annotation>
    <xs:documentation>Monto de descuento concedido, el cual es obligatorio si existe
descuento</xs:documentation>
  </xs:annotation>
</xs:element>
<xs:element name="NaturalezaDescuento" minOccurs="0">
  <xs:annotation>
    <xs:documentation>Naturaleza del descuento, que es obligatorio si existe
descuento</xs:documentation>
  </xs:annotation>
  <xs:simpleType>
    <xs:restriction base="xs:string">
      <xs:maxLength value="80"/>
    </xs:restriction>
  </xs:simpleType>

```

```

</xs:element>
<xs:element name="SubTotal" type="DecimalDineroType">
  <xs:annotation>
    <xs:documentation>Se obtiene de la resta del campo monto total menos monto de
descuento concedido</xs:documentation>
  </xs:annotation>
</xs:element>
<xs:element name="Exoneracion" type="ExoneracionType" minOccurs="0">
  <xs:annotation>
    <xs:documentation>Elemento para el detalle de la exoneración, si es
requerido</xs:documentation>
  </xs:annotation>
</xs:element>
<xs:element name="Impuesto" type="ImpuestoType" minOccurs="0"
maxOccurs="unbounded">
  <xs:annotation>
    <xs:documentation>Cuando el producto o servicio este gravado con algún impuesto se
debe indicar cada uno de ellos.</xs:documentation>
  </xs:annotation>
</xs:element>
<xs:element name="MontoTotalLinea" type="DecimalDineroType">
  <xs:annotation>
    <xs:documentation>Se obtiene de la suma de los campos subtotal más monto de los
impuestos</xs:documentation>
  </xs:annotation>
</xs:element>
</xs:sequence>
</xs:complexType>
</xs:element>
</xs:sequence>
</xs:complexType>
</xs:element>

```

element **FacturaElectronica/DetalleServicio/LineaDetalle**

diagram

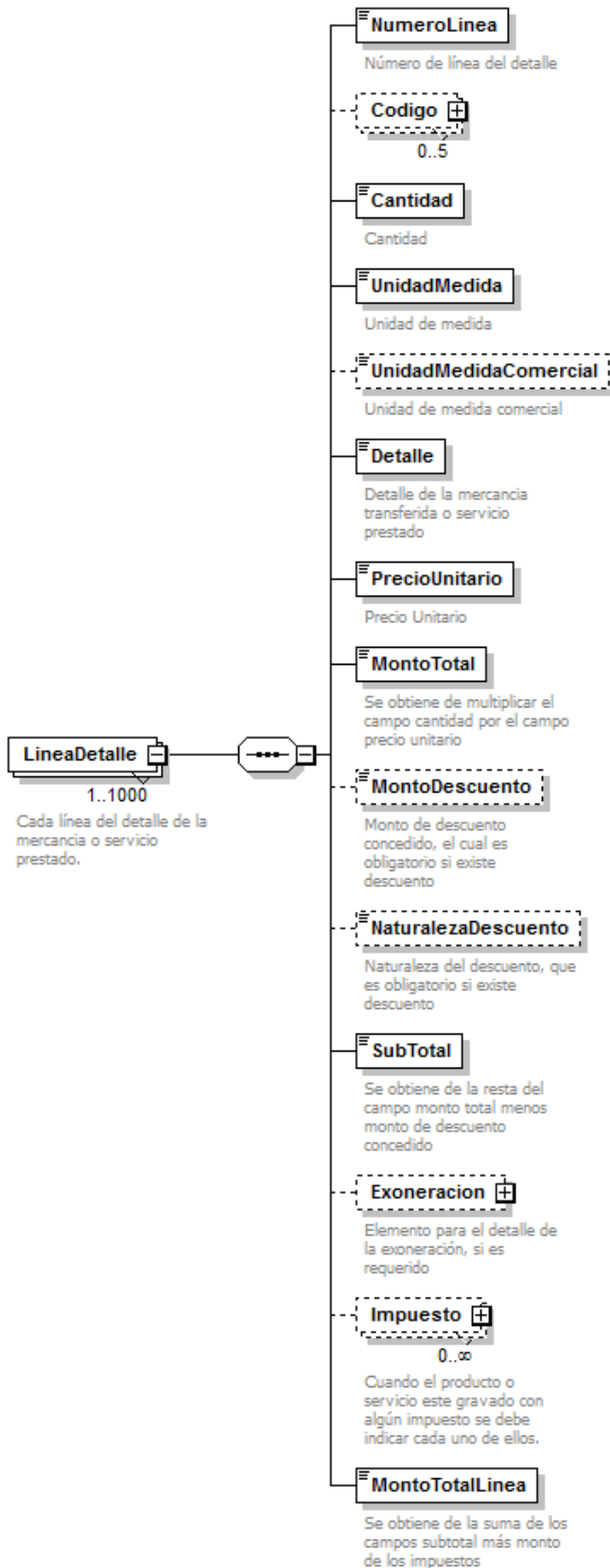

namespace	https://www.hacienda.go.cr/ATV/docs/esquemas/2016/v4/facturaElectronica
properties	minOcc 1 maxOcc 1000 content complex
children	NumeroLinea Codigo Cantidad UnidadMedida UnidadMedidaComercial Detalle PrecioUnitario MontoTotal MontoDescuento NaturalezaDescuento SubTotal Exoneracion Impuesto MontoTotalLinea
annotation	documentation Cada línea del detalle de la mercancía o servicio prestado.
source	<pre> <xs:element name="LineaDetalle" maxOccurs="1000"> <xs:annotation> <xs:documentation>Cada línea del detalle de la mercancía o servicio prestado.</xs:documentation> </xs:annotation> <xs:complexType> <xs:sequence> <xs:element name="NumeroLinea" type="xs:positiveInteger"> <xs:annotation> <xs:documentation>Número de línea del detalle</xs:documentation> </xs:annotation> </xs:element> <xs:element name="Codigo" type="CodigoType" minOccurs="0" maxOccurs="5"/> <xs:element name="Cantidad"> <xs:annotation> <xs:documentation>Cantidad</xs:documentation> </xs:annotation> <xs:simpleType> <xs:restriction base="xs:integer"> <xs:totalDigits value="13"/> </xs:restriction> </xs:simpleType> </xs:element> <xs:element name="UnidadMedida" type="UnidadMedidaType"> <xs:annotation> <xs:documentation>Unidad de medida </xs:documentation> </xs:annotation> </xs:element> <xs:element name="UnidadMedidaComercial" minOccurs="0"> <xs:annotation> <xs:documentation>Unidad de medida comercial</xs:documentation> </xs:annotation> <xs:simpleType> <xs:restriction base="xs:string"> <xs:maxLength value="20"/> </xs:restriction> </xs:simpleType> </xs:element> <xs:element name="Detalle"> <xs:annotation> <xs:documentation>Detalle de la mercancía transferida o servicio prestado</xs:documentation> </xs:annotation> <xs:simpleType> <xs:restriction base="xs:string"> <xs:maxLength value="160"/> </xs:restriction> </xs:simpleType> </xs:element> </xs:sequence> </xs:complexType> </xs:element> </pre>

```

</xs:element>
<xs:element name="PrecioUnitario" type="DecimalDineroType">
  <xs:annotation>
    <xs:documentation>Precio Unitario</xs:documentation>
  </xs:annotation>
</xs:element>
<xs:element name="MontoTotal" type="DecimalDineroType">
  <xs:annotation>
    <xs:documentation>Se obtiene de multiplicar el campo cantidad por el campo precio
unitario</xs:documentation>
  </xs:annotation>
</xs:element>
<xs:element name="MontoDescuento" type="DecimalDineroType" minOccurs="0">
  <xs:annotation>
    <xs:documentation>Monto de descuento concedido, el cual es obligatorio si existe
descuento</xs:documentation>
  </xs:annotation>
</xs:element>
<xs:element name="NaturalezaDescuento" minOccurs="0">
  <xs:annotation>
    <xs:documentation>Naturaleza del descuento, que es obligatorio si existe
descuento</xs:documentation>
  </xs:annotation>
  <xs:simpleType>
    <xs:restriction base="xs:string">
      <xs:maxLength value="80"/>
    </xs:restriction>
  </xs:simpleType>
</xs:element>
<xs:element name="SubTotal" type="DecimalDineroType">
  <xs:annotation>
    <xs:documentation>Se obtiene de la resta del campo monto total menos monto de
descuento concedido</xs:documentation>
  </xs:annotation>
</xs:element>
<xs:element name="Exoneracion" type="ExoneracionType" minOccurs="0">
  <xs:annotation>
    <xs:documentation>Elemento para el detalle de la exoneración, si es
requerido</xs:documentation>
  </xs:annotation>
</xs:element>
<xs:element name="Impuesto" type="ImpuestoType" minOccurs="0"
maxOccurs="unbounded">
  <xs:annotation>
    <xs:documentation>Cuando el producto o servicio este gravado con algún impuesto se debe
indicar cada uno de ellos.</xs:documentation>
  </xs:annotation>
</xs:element>
<xs:element name="MontoTotalLinea" type="DecimalDineroType">
  <xs:annotation>
    <xs:documentation>Se obtiene de la suma de los campos subtotal más monto de los
impuestos</xs:documentation>
  </xs:annotation>
</xs:element>
</xs:sequence>
</xs:complexType>

```

	</xs:element>
--	---------------

element **FacturaElectronica/DetalleServicio/LineaDetalle/NumeroLinea**

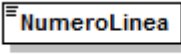
diagram	 <p>NumeroLinea Número de línea del detalle</p>
namespace	https://www.hacienda.go.cr/ATV/docs/esquemas/2016/v4/facturaElectronica
type	xs:positiveInteger
properties	content simple
annotation	documentation Número de línea del detalle
source	<pre><xs:element name="NumeroLinea" type="xs:positiveInteger"> <xs:annotation> <xs:documentation>Número de línea del detalle</xs:documentation> </xs:annotation> </xs:element></pre>

element **FacturaElectronica/DetalleServicio/LineaDetalle/Codigo**

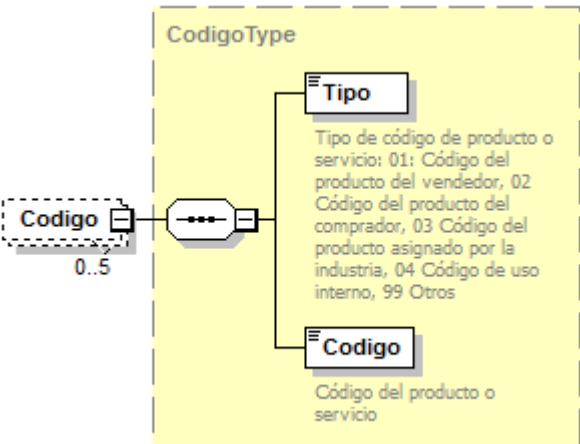
diagram	 <p>The diagram shows a complex type 'CodigoType' (yellow background) containing two elements: 'Tipo' and 'Codigo'. 'Tipo' is described as 'Tipo de código de producto o servicio: 01: Código del producto del vendedor, 02 Código del producto del comprador, 03 Código del producto asignado por la industria, 04 Código de uso interno, 99 Otros'. 'Codigo' is described as 'Código del producto o servicio'. To the left, a 'Codigo' element is shown with a cardinality of '0..5'.</p>
namespace	https://www.hacienda.go.cr/ATV/docs/esquemas/2016/v4/facturaElectronica
type	CodigoType
properties	minOcc 0 maxOcc 5 content complex
children	Tipo Codigo
source	<pre><xs:element name="Codigo" type="CodigoType" minOccurs="0" maxOccurs="5"/></pre>

element **FacturaElectronica/DetalleServicio/LineaDetalle/Cantidad**

diagram	 <p>Cantidad Cantidad</p>
---------	------------------------------------------------------------------------------------------------------------------

namespace	https://www.hacienda.go.cr/ATV/docs/esquemas/2016/v4/facturaElectronica						
type	restriction of xs:integer						
properties	content simple						
facets	<table border="1"> <thead> <tr> <th>Kind</th> <th>Value</th> <th>Annotation</th> </tr> </thead> <tbody> <tr> <td>totalDigits</td> <td>13</td> <td></td> </tr> </tbody> </table>	Kind	Value	Annotation	totalDigits	13	
Kind	Value	Annotation					
totalDigits	13						
annotation	documentation Cantidad						
source	<pre> <xs:element name="Cantidad"> <xs:annotation> <xs:documentation>Cantidad</xs:documentation> </xs:annotation> <xs:simpleType> <xs:restriction base="xs:integer"> <xs:totalDigits value="13"/> </xs:restriction> </xs:simpleType> </xs:element> </pre>						

element **FacturaElectronica/DetalleServicio/LineaDetalle/UnidadMedida**

diagram																																																				
namespace	https://www.hacienda.go.cr/ATV/docs/esquemas/2016/v4/facturaElectronica																																																			
type	UnidadMedidaType																																																			
properties	content simple																																																			
facets	<table border="1"> <thead> <tr> <th>Kind</th> <th>Value</th> <th>Annotation</th> </tr> </thead> <tbody> <tr> <td>enumeration</td> <td>Sp</td> <td>documentation Servicios Profesionales</td> </tr> <tr> <td>enumeration</td> <td>m</td> <td>documentation Metro</td> </tr> <tr> <td>enumeration</td> <td>kg</td> <td>documentation Kilogramo</td> </tr> <tr> <td>enumeration</td> <td>s</td> <td>documentation Segundo</td> </tr> <tr> <td>enumeration</td> <td>A</td> <td>documentation Ampere</td> </tr> <tr> <td>enumeration</td> <td>K</td> <td>documentation Kelvin</td> </tr> <tr> <td>enumeration</td> <td>mol</td> <td>documentation Mol</td> </tr> <tr> <td>enumeration</td> <td>cd</td> <td>documentation Candela</td> </tr> <tr> <td>enumeration</td> <td>m²</td> <td>documentation metro cuadrado</td> </tr> <tr> <td>enumeration</td> <td>m³</td> <td>documentation metro cúbico</td> </tr> <tr> <td>enumeration</td> <td>m/s</td> <td>documentation metro por segundo</td> </tr> <tr> <td>enumeration</td> <td>m/s²</td> <td>documentation metro por segundo cuadrado</td> </tr> <tr> <td>enumeration</td> <td>1/m</td> <td>documentation 1 por metro</td> </tr> <tr> <td>enumeration</td> <td>kg/m³</td> <td>documentation kilogramo por metro cúbico</td> </tr> <tr> <td>enumeration</td> <td>A/m²</td> <td>documentation ampere por metro cuadrado</td> </tr> <tr> <td>enumeration</td> <td>A/m</td> <td>documentation</td> </tr> </tbody> </table>	Kind	Value	Annotation	enumeration	Sp	documentation Servicios Profesionales	enumeration	m	documentation Metro	enumeration	kg	documentation Kilogramo	enumeration	s	documentation Segundo	enumeration	A	documentation Ampere	enumeration	K	documentation Kelvin	enumeration	mol	documentation Mol	enumeration	cd	documentation Candela	enumeration	m ²	documentation metro cuadrado	enumeration	m ³	documentation metro cúbico	enumeration	m/s	documentation metro por segundo	enumeration	m/s ²	documentation metro por segundo cuadrado	enumeration	1/m	documentation 1 por metro	enumeration	kg/m ³	documentation kilogramo por metro cúbico	enumeration	A/m ²	documentation ampere por metro cuadrado	enumeration	A/m	documentation
Kind	Value	Annotation																																																		
enumeration	Sp	documentation Servicios Profesionales																																																		
enumeration	m	documentation Metro																																																		
enumeration	kg	documentation Kilogramo																																																		
enumeration	s	documentation Segundo																																																		
enumeration	A	documentation Ampere																																																		
enumeration	K	documentation Kelvin																																																		
enumeration	mol	documentation Mol																																																		
enumeration	cd	documentation Candela																																																		
enumeration	m ²	documentation metro cuadrado																																																		
enumeration	m ³	documentation metro cúbico																																																		
enumeration	m/s	documentation metro por segundo																																																		
enumeration	m/s ²	documentation metro por segundo cuadrado																																																		
enumeration	1/m	documentation 1 por metro																																																		
enumeration	kg/m ³	documentation kilogramo por metro cúbico																																																		
enumeration	A/m ²	documentation ampere por metro cuadrado																																																		
enumeration	A/m	documentation																																																		

enumeration	mol/m ³	ampere por metro documentation mol por metro cúbico
enumeration	cd/m ²	documentation candela por metro cuadrado
enumeration	1	documentation uno (índice de refracción)
enumeration	rad	documentation radián
enumeration	sr	documentation estereorradián
enumeration	Hz	documentation hertz
enumeration	N	documentation newton
enumeration	Pa	documentation pascal
enumeration	J	documentation Joule
enumeration	W	documentation Watt
enumeration	C	documentation coulomb
enumeration	V	documentation volt
enumeration	F	documentation farad
enumeration	Ω	documentation ohm
enumeration	S	documentation siemens
enumeration	Wb	documentation weber
enumeration	T	documentation tesla
enumeration	H	documentation henry
enumeration	°C	documentation grado Celsius
enumeration	lm	documentation lumen
enumeration	lx	documentation lux
enumeration	Bq	documentation Becquerel
enumeration	Gy	documentation gray
enumeration	Sv	documentation sievert
enumeration	kat	documentation katal
enumeration	Pa·s	documentation pascal segundo
enumeration	N·m	documentation newton metro
enumeration	N/m	documentation newton por metro
enumeration	rad/s	documentation radián por segundo
enumeration	rad/s ²	documentation radián por segundo cuadrado
enumeration	W/m ²	documentation watt por metro cuadrado
enumeration	J/K	documentation joule por kelvin
enumeration	J/(kg·K)	documentation joule por kilogramo kelvin
enumeration	J/kg	documentation joule por kilogramo
enumeration	W/(m·K)	documentation

enumeration	J/m ³	watt por metro kevin documentation
enumeration	V/m	joule por metro cúbico documentation
enumeration	C/m ³	volt por metro documentation
enumeration	C/m ²	coulomb por metro cúbico documentation
enumeration	F/m	coulomb por metro cuadrado documentation
enumeration	H/m	farad por metro documentation
enumeration	J/mol	henry por metro documentation
enumeration	J/(mol·K)	joule por mol documentation
enumeration	C/kg	joule por mol kelvin documentation
enumeration	Gy/s	coulomb por kilogramo documentation
enumeration	W/sr	gray por segundo documentation
enumeration	W/(m ² ·sr)	watt por estereorradián documentation
enumeration	kat/m ³	watt por metro cuadrado estereorradián documentation
enumeration	min	katal por metro cúbico documentation
enumeration	h	minuto documentation
enumeration	d	hora documentation
enumeration	°	día documentation
enumeration	'	grado documentation
enumeration	''	minuto documentation
enumeration	L	segundo documentation
enumeration	t	litro documentation
enumeration	Np	tonelada documentation
enumeration	B	neper documentation
enumeration	eV	bel documentation
enumeration	u	electronvolt documentation
enumeration	ua	unidad de masa atómica unificada documentation
enumeration	Unid	unidad astronómica documentation
enumeration	Gal	unidad documentation
enumeration	g	galón documentation
enumeration	Km	gramo documentation
enumeration	ln	kilometro documentation
enumeration	cm	pulgada documentation
enumeration	mL	centimetro documentation
enumeration	mm	mililitro documentation
enumeration	Oz	milimetro documentation

	enumeration Otros onzas
annotation	documentation Unidad de medida
source	<pre><xs:element name="UnidadMedida" type="UnidadMedidaType"> <xs:annotation> <xs:documentation>Unidad de medida </xs:documentation> </xs:annotation> </xs:element></pre>

element FacturaElectronica/DetalleServicio/LineaDetalle/UnidadMedidaComercial

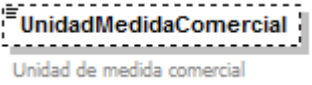
diagram	
namespace	https://www.hacienda.go.cr/ATV/docs/esquemas/2016/v4/facturaElectronica
type	restriction of xs:string
properties	minOcc 0 maxOcc 1 content simple
facets	Kind Value Annotation maxLength 20
annotation	documentation Unidad de medida comercial
source	<pre><xs:element name="UnidadMedidaComercial" minOccurs="0"> <xs:annotation> <xs:documentation>Unidad de medida comercial</xs:documentation> </xs:annotation> <xs:simpleType> <xs:restriction base="xs:string"> <xs:maxLength value="20"/> </xs:restriction> </xs:simpleType> </xs:element></pre>

element FacturaElectronica/DetalleServicio/LineaDetalle/Detalle

diagram	
namespace	https://www.hacienda.go.cr/ATV/docs/esquemas/2016/v4/facturaElectronica
type	restriction of xs:string
properties	content simple
facets	Kind Value Annotation maxLength 160
annotation	documentation Detalle de la mercancia transferida o servicio prestado
source	<pre><xs:element name="Detalle"> <xs:annotation></pre>

	<pre> <xs:documentation>Detalle de la mercancia transferida o servicio prestado</xs:documentation> </xs:annotation> <xs:simpleType> <xs:restriction base="xs:string"> <xs:maxLength value="160"/> </xs:restriction> </xs:simpleType> </xs:element> </pre>
--	-------------------------------------------------------------------------------------------------------------------------------------------------------------------------------------------------------------------------------------------------------------------------------------------------------------------------

element **FacturaElectronica/DetalleServicio/LineaDetalle/PrecioUnitario**

diagram										
namespace	https://www.hacienda.go.cr/ATV/docs/esquemas/2016/v4/facturaElectronica									
type	DecimalDineroType									
properties	content simple									
facets	<table border="1"> <thead> <tr> <th>Kind</th> <th>Value</th> <th>Annotation</th> </tr> </thead> <tbody> <tr> <td>totalDigits</td> <td>18</td> <td></td> </tr> <tr> <td>fractionDigits</td> <td>5</td> <td></td> </tr> </tbody> </table>	Kind	Value	Annotation	totalDigits	18		fractionDigits	5	
Kind	Value	Annotation								
totalDigits	18									
fractionDigits	5									
annotation	documentation Precio Unitario									
source	<pre> <xs:element name="PrecioUnitario" type="DecimalDineroType"> <xs:annotation> <xs:documentation>Precio Unitario</xs:documentation> </xs:annotation> </xs:element> </pre>									

element **FacturaElectronica/DetalleServicio/LineaDetalle/MontoTotal**

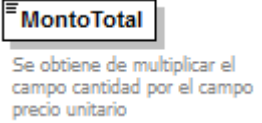
diagram										
namespace	https://www.hacienda.go.cr/ATV/docs/esquemas/2016/v4/facturaElectronica									
type	DecimalDineroType									
properties	content simple									
facets	<table border="1"> <thead> <tr> <th>Kind</th> <th>Value</th> <th>Annotation</th> </tr> </thead> <tbody> <tr> <td>totalDigits</td> <td>18</td> <td></td> </tr> <tr> <td>fractionDigits</td> <td>5</td> <td></td> </tr> </tbody> </table>	Kind	Value	Annotation	totalDigits	18		fractionDigits	5	
Kind	Value	Annotation								
totalDigits	18									
fractionDigits	5									
annotation	documentation Se obtiene de multiplicar el campo cantidad por el campo precio unitario									
source	<pre> <xs:element name="MontoTotal" type="DecimalDineroType"> <xs:annotation> <xs:documentation>Se obtiene de multiplicar el campo cantidad por el campo precio unitario</xs:documentation> </xs:annotation> </xs:element> </pre>									

element **FacturaElectronica/DetalleServicio/LineaDetalle/MontoDescuento**

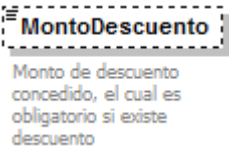
diagram	
namespace	https://www.hacienda.go.cr/ATV/docs/esquemas/2016/v4/facturaElectronica
type	DecimalDineroType
properties	minOcc 0 maxOcc 1 content simple
facets	Kind Value Annotation totalDigits 18 fractionDigits 5
annotation	documentation Monto de descuento concedido, el cual es obligatorio si existe descuento
source	<pre><xs:element name="MontoDescuento" type="DecimalDineroType" minOccurs="0"> <xs:annotation> <xs:documentation>Monto de descuento concedido, el cual es obligatorio si existe descuento</xs:documentation> </xs:annotation> </xs:element></pre>

element **FacturaElectronica/DetalleServicio/LineaDetalle/NaturalezaDescuento**

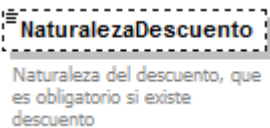
diagram	
namespace	https://www.hacienda.go.cr/ATV/docs/esquemas/2016/v4/facturaElectronica
type	restriction of xs:string
properties	minOcc 0 maxOcc 1 content simple
facets	Kind Value Annotation maxLength 80
annotation	documentation Naturaleza del descuento, que es obligatorio si existe descuento
source	<pre><xs:element name="NaturalezaDescuento" minOccurs="0"> <xs:annotation> <xs:documentation>Naturaleza del descuento, que es obligatorio si existe descuento</xs:documentation> </xs:annotation> <xs:simpleType> <xs:restriction base="xs:string"> <xs:maxLength value="80"/> </xs:restriction> </xs:simpleType> </xs:element></pre>

element **FacturaElectronica/DetalleServicio/LineaDetalle/SubTotal**

diagram	 <p>Se obtiene de la resta del campo monto total menos monto de descuento concedido</p>									
namespace	https://www.hacienda.go.cr/ATV/docs/esquemas/2016/v4/facturaElectronica									
type	DecimalDineroType									
properties	content simple									
facets	<table border="1"> <thead> <tr> <th>Kind</th> <th>Value</th> <th>Annotation</th> </tr> </thead> <tbody> <tr> <td>totalDigits</td> <td>18</td> <td></td> </tr> <tr> <td>fractionDigits</td> <td>5</td> <td></td> </tr> </tbody> </table>	Kind	Value	Annotation	totalDigits	18		fractionDigits	5	
Kind	Value	Annotation								
totalDigits	18									
fractionDigits	5									
annotation	<p>documentation</p> <p>Se obtiene de la resta del campo monto total menos monto de descuento concedido</p>									
source	<pre><xs:element name="SubTotal" type="DecimalDineroType"> <xs:annotation> <xs:documentation>Se obtiene de la resta del campo monto total menos monto de descuento concedido</xs:documentation> </xs:annotation> </xs:element></pre>									

element **FacturaElectronica/DetalleServicio/LineaDetalle/Exoneracion**

<p>diagram</p>	
<p>namespace</p>	<p>https://www.hacienda.go.cr/ATV/docs/esquemas/2016/v4/facturaElectronica</p>
<p>type</p>	<p>ExoneracionType</p>
<p>properties</p>	<p>minOcc 0 maxOcc 1 content complex</p>
<p>children</p>	<p>TipoDocumento NumeroDocumento NombreInstitucion FechaEmision MontoImpuesto PorcentajeCompra</p>
<p>annotation</p>	<p>documentation Elemento para el detalle de la exoneración, si es requerido</p>
<p>source</p>	<pre><xs:element name="Exoneracion" type="ExoneracionType" minOccurs="0"> <xs:annotation> <xs:documentation>Elemento para el detalle de la exoneración, si es requerido</xs:documentation> </xs:annotation> </xs:element></pre>

element **FacturaElectronica/DetalleServicio/LineaDetalle/Impuesto**

<p>diagram</p>	
<p>namespace</p>	<p>https://www.hacienda.go.cr/ATV/docs/esquemas/2016/v4/facturaElectronica</p>
<p>type</p>	<p>ImpuestoType</p>
<p>properties</p>	<p>minOcc 0 maxOcc unbounded content complex</p>
<p>children</p>	<p>Codigo Tarifa Monto</p>
<p>annotation</p>	<p>documentation Cuando el producto o servicio este gravado con algún impuesto se debe indicar cada uno de ellos.</p>
<p>source</p>	<pre><xs:element name="Impuesto" type="ImpuestoType" minOccurs="0" maxOccurs="unbounded"> <xs:annotation> <xs:documentation>Cuando el producto o servicio este gravado con algún impuesto se debe indicar cada uno de ellos.</xs:documentation> </xs:annotation> </xs:element></pre>

element **FacturaElectronica/DetalleServicio/LineaDetalle/MontoTotalLinea**

diagram	 <p>MontoTotalLinea</p> <p>Se obtiene de la suma de los campos subtotal más monto de los impuestos</p>									
namespace	https://www.hacienda.go.cr/ATV/docs/esquemas/2016/v4/facturaElectronica									
type	DecimalDineroType									
properties	content simple									
facets	<table border="1"> <thead> <tr> <th>Kind</th> <th>Value</th> <th>Annotation</th> </tr> </thead> <tbody> <tr> <td>totalDigits</td> <td>18</td> <td></td> </tr> <tr> <td>fractionDigits</td> <td>5</td> <td></td> </tr> </tbody> </table>	Kind	Value	Annotation	totalDigits	18		fractionDigits	5	
Kind	Value	Annotation								
totalDigits	18									
fractionDigits	5									
annotation	<p>documentation</p> <p>Se obtiene de la suma de los campos subtotal más monto de los impuestos</p>									
source	<pre><xs:element name="MontoTotalLinea" type="DecimalDineroType"> <xs:annotation> <xs:documentation>Se obtiene de la suma de los campos subtotal más monto de los impuestos</xs:documentation> </xs:annotation> </xs:element></pre>									

element **FacturaElectronica/ResumenFactura**

diagram

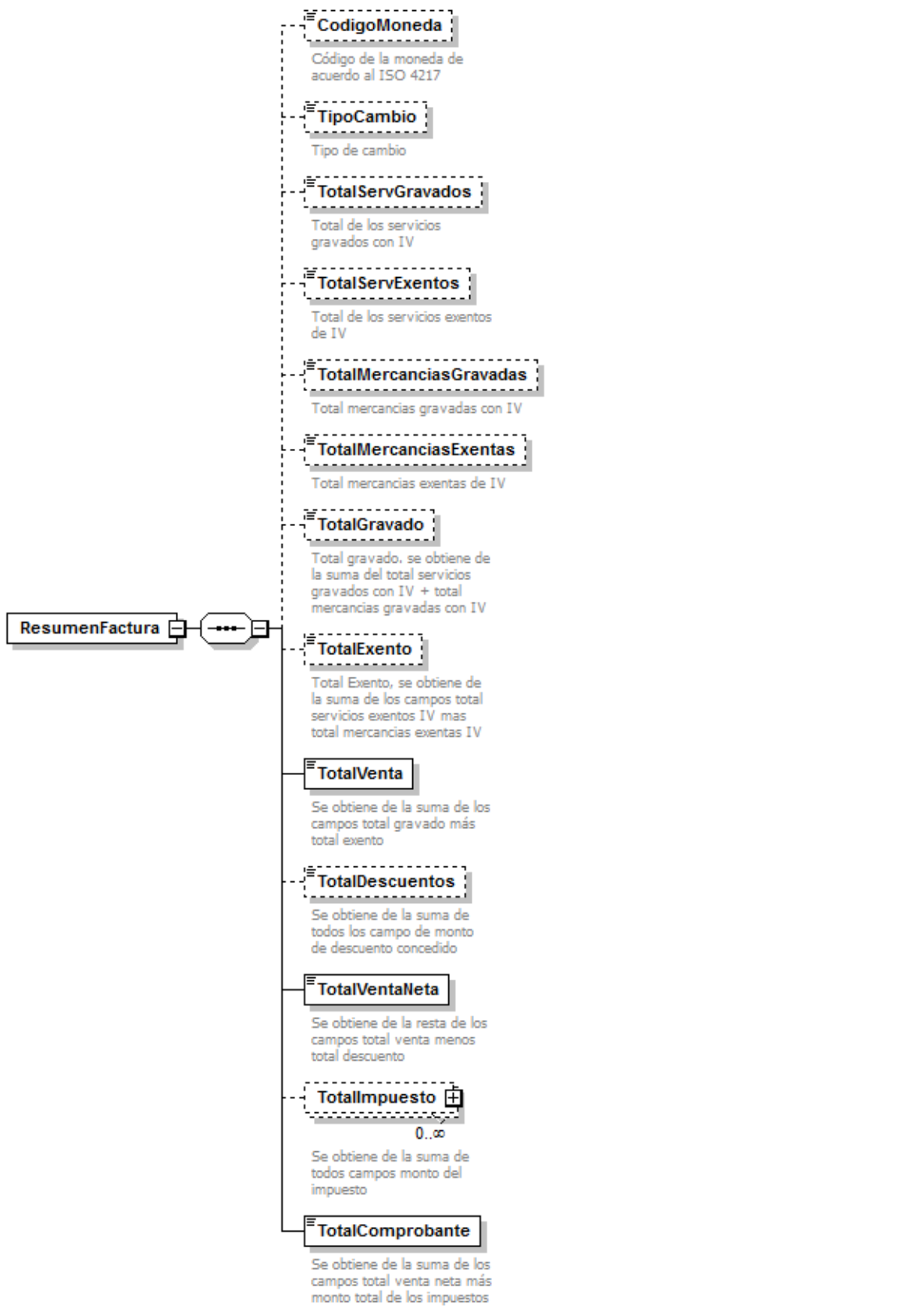

namespace	https://www.hacienda.go.cr/ATV/docs/esquemas/2016/v4/facturaElectronica
properties	content complex
children	CodigoMoneda TipoCambio TotalServGravados TotalServExentos TotalMercanciasGravadas TotalMercanciasExentas TotalGravado TotalExento TotalVenta TotalDescuentos TotalVentaNeta TotalImpuesto TotalComprobante
source	<pre> <xs:element name="ResumenFactura"> <xs:complexType> <xs:sequence> <xs:element name="CodigoMoneda" minOccurs="0"> <xs:annotation> <xs:documentation>Código de la moneda de acuerdo al ISO 4217</xs:documentation> </xs:annotation> <xs:simpleType> <xs:restriction base="xs:string"> <xs:enumeration value="AED"/> <xs:enumeration value="AFN"/> <xs:enumeration value="ALL"/> <xs:enumeration value="AMD"/> <xs:enumeration value="ANG"/> <xs:enumeration value="AOA"/> <xs:enumeration value="ARS"/> <xs:enumeration value="AUD"/> <xs:enumeration value="AWG"/> <xs:enumeration value="AZN"/> <xs:enumeration value="BAM"/> <xs:enumeration value="BBD"/> <xs:enumeration value="BDT"/> <xs:enumeration value="BGN"/> <xs:enumeration value="BHD"/> <xs:enumeration value="BIF"/> <xs:enumeration value="BMD"/> <xs:enumeration value="BND"/> <xs:enumeration value="BOB"/> <xs:enumeration value="BOV"/> <xs:enumeration value="BRL"/> <xs:enumeration value="BSD"/> <xs:enumeration value="BTN"/> <xs:enumeration value="BWP"/> <xs:enumeration value="BYR"/> <xs:enumeration value="BZD"/> <xs:enumeration value="CAD"/> <xs:enumeration value="CDF"/> <xs:enumeration value="CHE"/> <xs:enumeration value="CHF"/> <xs:enumeration value="CHW"/> <xs:enumeration value="CLF"/> <xs:enumeration value="CLP"/> <xs:enumeration value="CNY"/> <xs:enumeration value="COP"/> <xs:enumeration value="COU"/> <xs:enumeration value="CRC"/> <xs:enumeration value="CUC"/> <xs:enumeration value="CUP"/> <xs:enumeration value="CVE"/> </xs:restriction> </xs:simpleType> </xs:element> </xs:sequence> </xs:complexType> </xs:element> </pre>

<xs:enumeration value="CZK"/>
<xs:enumeration value="DJF"/>
<xs:enumeration value="DKK"/>
<xs:enumeration value="DOP"/>
<xs:enumeration value="DZD"/>
<xs:enumeration value="EGP"/>
<xs:enumeration value="ERN"/>
<xs:enumeration value="ETB"/>
<xs:enumeration value="EUR"/>
<xs:enumeration value="FJD"/>
<xs:enumeration value="FKP"/>
<xs:enumeration value="GBP"/>
<xs:enumeration value="GEL"/>
<xs:enumeration value="GHS"/>
<xs:enumeration value="GIP"/>
<xs:enumeration value="GMD"/>
<xs:enumeration value="GNF"/>
<xs:enumeration value="GTQ"/>
<xs:enumeration value="GYD"/>
<xs:enumeration value="HKD"/>
<xs:enumeration value="HNL"/>
<xs:enumeration value="HRK"/>
<xs:enumeration value="HTG"/>
<xs:enumeration value="HUF"/>
<xs:enumeration value="IDR"/>
<xs:enumeration value="ILS"/>
<xs:enumeration value="INR"/>
<xs:enumeration value="IQD"/>
<xs:enumeration value="IRR"/>
<xs:enumeration value="ISK"/>
<xs:enumeration value="JMD"/>
<xs:enumeration value="JOD"/>
<xs:enumeration value="JPY"/>
<xs:enumeration value="KES"/>
<xs:enumeration value="KGS"/>
<xs:enumeration value="KHR"/>
<xs:enumeration value="KMF"/>
<xs:enumeration value="KPW"/>
<xs:enumeration value="KRW"/>
<xs:enumeration value="KWD"/>
<xs:enumeration value="KYD"/>
<xs:enumeration value="KZT"/>
<xs:enumeration value="LAK"/>
<xs:enumeration value="LBP"/>
<xs:enumeration value="LKR"/>
<xs:enumeration value="LRD"/>
<xs:enumeration value="LSL"/>
<xs:enumeration value="LYD"/>
<xs:enumeration value="MAD"/>
<xs:enumeration value="MDL"/>
<xs:enumeration value="MGA"/>
<xs:enumeration value="MKD"/>
<xs:enumeration value="MMK"/>
<xs:enumeration value="MNT"/>
<xs:enumeration value="MOP"/>
<xs:enumeration value="MRO"/>

```
<xs:enumeration value="MUR"/>
<xs:enumeration value="MVR"/>
<xs:enumeration value="MWK"/>
<xs:enumeration value="MXN"/>
<xs:enumeration value="MXV"/>
<xs:enumeration value="MYR"/>
<xs:enumeration value="MZN"/>
<xs:enumeration value="NAD"/>
<xs:enumeration value="NGN"/>
<xs:enumeration value="NIO"/>
<xs:enumeration value="NOK"/>
<xs:enumeration value="NPR"/>
<xs:enumeration value="NZD"/>
<xs:enumeration value="OMR"/>
<xs:enumeration value="PAB"/>
<xs:enumeration value="PEN"/>
<xs:enumeration value="PGK"/>
<xs:enumeration value="PHP"/>
<xs:enumeration value="PKR"/>
<xs:enumeration value="PLN"/>
<xs:enumeration value="PYG"/>
<xs:enumeration value="QAR"/>
<xs:enumeration value="RON"/>
<xs:enumeration value="RSD"/>
<xs:enumeration value="RUB"/>
<xs:enumeration value="RWF"/>
<xs:enumeration value="SAR"/>
<xs:enumeration value="SBD"/>
<xs:enumeration value="SCR"/>
<xs:enumeration value="SDG"/>
<xs:enumeration value="SEK"/>
<xs:enumeration value="SGD"/>
<xs:enumeration value="SHP"/>
<xs:enumeration value="SLL"/>
<xs:enumeration value="SOS"/>
<xs:enumeration value="SRD"/>
<xs:enumeration value="SSP"/>
<xs:enumeration value="STD"/>
<xs:enumeration value="SVC"/>
<xs:enumeration value="SYP"/>
<xs:enumeration value="SZL"/>
<xs:enumeration value="THB"/>
<xs:enumeration value="TJS"/>
<xs:enumeration value="TMT"/>
<xs:enumeration value="TND"/>
<xs:enumeration value="TOP"/>
<xs:enumeration value="TRY"/>
<xs:enumeration value="TTD"/>
<xs:enumeration value="TWD"/>
<xs:enumeration value="TZS"/>
<xs:enumeration value="UAH"/>
<xs:enumeration value="UGX"/>
<xs:enumeration value="USD"/>
<xs:enumeration value="USN"/>
<xs:enumeration value="UYI"/>
<xs:enumeration value="UYU"/>
```

```

<xs:enumeration value="UZS"/>
<xs:enumeration value="VEF"/>
<xs:enumeration value="VND"/>
<xs:enumeration value="VUV"/>
<xs:enumeration value="WST"/>
<xs:enumeration value="XAF"/>
<xs:enumeration value="XAG"/>
<xs:enumeration value="XAU"/>
<xs:enumeration value="XBA"/>
<xs:enumeration value="XBB"/>
<xs:enumeration value="XBC"/>
<xs:enumeration value="XBD"/>
<xs:enumeration value="XCD"/>
<xs:enumeration value="XDR"/>
<xs:enumeration value="XOF"/>
<xs:enumeration value="XPD"/>
<xs:enumeration value="XPF"/>
<xs:enumeration value="XPT"/>
<xs:enumeration value="XSU"/>
<xs:enumeration value="XTS"/>
<xs:enumeration value="XUA"/>
<xs:enumeration value="XXX"/>
<xs:enumeration value="YER"/>
<xs:enumeration value="ZAR"/>
<xs:enumeration value="ZMW"/>
<xs:enumeration value="ZWL"/>
</xs:restriction>
</xs:simpleType>
</xs:element>
<xs:element name="TipoCambio" type="DecimalDineroType" minOccurs="0">
  <xs:annotation>
    <xs:documentation>Tipo de cambio</xs:documentation>
  </xs:annotation>
</xs:element>
<xs:element name="TotalServGravados" type="DecimalDineroType" minOccurs="0">
  <xs:annotation>
    <xs:documentation>Total de los servicios gravados con IV</xs:documentation>
  </xs:annotation>
</xs:element>
<xs:element name="TotalServExentos" type="DecimalDineroType" minOccurs="0">
  <xs:annotation>
    <xs:documentation>Total de los servicios exentos de IV</xs:documentation>
  </xs:annotation>
</xs:element>
<xs:element name="TotalMercanciasGravadas" type="DecimalDineroType" minOccurs="0">
  <xs:annotation>
    <xs:documentation>Total mercancias gravadas con IV</xs:documentation>
  </xs:annotation>
</xs:element>
<xs:element name="TotalMercanciasExentas" type="DecimalDineroType" minOccurs="0">
  <xs:annotation>
    <xs:documentation>Total mercancias exentas de IV</xs:documentation>
  </xs:annotation>
</xs:element>
<xs:element name="TotalGravado" type="DecimalDineroType" minOccurs="0">
  <xs:annotation>

```

```

<xs:documentation>Total gravado. se obtiene de la suma del total servicios gravados con IV
+ total mercancías gravadas con IV</xs:documentation>
</xs:annotation>
</xs:element>
<xs:element name="TotalExento" type="DecimalDineroType" minOccurs="0">
<xs:annotation>
<xs:documentation>Total Exento, se obtiene de la suma de los campos total servicios
exentos IV mas total mercancías exentas IV</xs:documentation>
</xs:annotation>
</xs:element>
<xs:element name="TotalVenta" type="DecimalDineroType">
<xs:annotation>
<xs:documentation>Se obtiene de la suma de los campos total gravado más total
exento</xs:documentation>
</xs:annotation>
</xs:element>
<xs:element name="TotalDescuentos" type="DecimalDineroType" minOccurs="0">
<xs:annotation>
<xs:documentation>Se obtiene de la suma de todos los campo de monto de descuento
concedido</xs:documentation>
</xs:annotation>
</xs:element>
<xs:element name="TotalVentaNeta" type="DecimalDineroType">
<xs:annotation>
<xs:documentation>Se obtiene de la resta de los campos total venta menos total
descuento</xs:documentation>
</xs:annotation>
</xs:element>
<xs:element name="TotalImpuesto" type="ImpuestoType" minOccurs="0"
maxOccurs="unbounded">
<xs:annotation>
<xs:documentation>Se obtiene de la suma de todos campos monto del
impuesto</xs:documentation>
</xs:annotation>
</xs:element>
<xs:element name="TotalComprobante" type="DecimalDineroType">
<xs:annotation>
<xs:documentation>Se obtiene de la suma de los campos total venta neta más monto total
de los impuestos</xs:documentation>
</xs:annotation>
</xs:element>
</xs:sequence>
</xs:complexType>
</xs:element>

```

element **FacturaElectronica/ResumenFactura/CodigoMoneda**

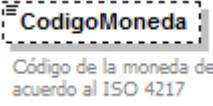
diagram	
namespace	https://www.hacienda.go.cr/ATV/docs/esquemas/2016/v4/facturaElectronica
type	restriction of xs:string

properties	minOcc 0 maxOcc 1 content simple																																																																																																																																							
facets	<table border="0"> <thead> <tr> <th data-bbox="289 264 435 289">Kind</th> <th data-bbox="435 264 521 289">Value</th> <th data-bbox="521 264 1463 289">Annotation</th> </tr> </thead> <tbody> <tr><td>enumeration</td><td>AED</td><td></td></tr> <tr><td>enumeration</td><td>AFN</td><td></td></tr> <tr><td>enumeration</td><td>ALL</td><td></td></tr> <tr><td>enumeration</td><td>AMD</td><td></td></tr> <tr><td>enumeration</td><td>ANG</td><td></td></tr> <tr><td>enumeration</td><td>AOA</td><td></td></tr> <tr><td>enumeration</td><td>ARS</td><td></td></tr> <tr><td>enumeration</td><td>AUD</td><td></td></tr> <tr><td>enumeration</td><td>AWG</td><td></td></tr> <tr><td>enumeration</td><td>AZN</td><td></td></tr> <tr><td>enumeration</td><td>BAM</td><td></td></tr> <tr><td>enumeration</td><td>BBD</td><td></td></tr> <tr><td>enumeration</td><td>BDT</td><td></td></tr> <tr><td>enumeration</td><td>BGN</td><td></td></tr> <tr><td>enumeration</td><td>BHD</td><td></td></tr> <tr><td>enumeration</td><td>BIF</td><td></td></tr> <tr><td>enumeration</td><td>BMD</td><td></td></tr> <tr><td>enumeration</td><td>BND</td><td></td></tr> <tr><td>enumeration</td><td>BOB</td><td></td></tr> <tr><td>enumeration</td><td>BOV</td><td></td></tr> <tr><td>enumeration</td><td>BRL</td><td></td></tr> <tr><td>enumeration</td><td>BSD</td><td></td></tr> <tr><td>enumeration</td><td>BTN</td><td></td></tr> <tr><td>enumeration</td><td>BWP</td><td></td></tr> <tr><td>enumeration</td><td>BYR</td><td></td></tr> <tr><td>enumeration</td><td>BZD</td><td></td></tr> <tr><td>enumeration</td><td>CAD</td><td></td></tr> <tr><td>enumeration</td><td>CDF</td><td></td></tr> <tr><td>enumeration</td><td>CHE</td><td></td></tr> <tr><td>enumeration</td><td>CHF</td><td></td></tr> <tr><td>enumeration</td><td>CHW</td><td></td></tr> <tr><td>enumeration</td><td>CLF</td><td></td></tr> <tr><td>enumeration</td><td>CLP</td><td></td></tr> <tr><td>enumeration</td><td>CNY</td><td></td></tr> <tr><td>enumeration</td><td>COP</td><td></td></tr> <tr><td>enumeration</td><td>COU</td><td></td></tr> <tr><td>enumeration</td><td>CRC</td><td></td></tr> <tr><td>enumeration</td><td>CUC</td><td></td></tr> <tr><td>enumeration</td><td>CUP</td><td></td></tr> <tr><td>enumeration</td><td>CVE</td><td></td></tr> <tr><td>enumeration</td><td>CZK</td><td></td></tr> <tr><td>enumeration</td><td>DJF</td><td></td></tr> <tr><td>enumeration</td><td>DKK</td><td></td></tr> <tr><td>enumeration</td><td>DOP</td><td></td></tr> </tbody> </table>	Kind	Value	Annotation	enumeration	AED		enumeration	AFN		enumeration	ALL		enumeration	AMD		enumeration	ANG		enumeration	AOA		enumeration	ARS		enumeration	AUD		enumeration	AWG		enumeration	AZN		enumeration	BAM		enumeration	BBD		enumeration	BDT		enumeration	BGN		enumeration	BHD		enumeration	BIF		enumeration	BMD		enumeration	BND		enumeration	BOB		enumeration	BOV		enumeration	BRL		enumeration	BSD		enumeration	BTN		enumeration	BWP		enumeration	BYR		enumeration	BZD		enumeration	CAD		enumeration	CDF		enumeration	CHE		enumeration	CHF		enumeration	CHW		enumeration	CLF		enumeration	CLP		enumeration	CNY		enumeration	COP		enumeration	COU		enumeration	CRC		enumeration	CUC		enumeration	CUP		enumeration	CVE		enumeration	CZK		enumeration	DJF		enumeration	DKK		enumeration	DOP	
Kind	Value	Annotation																																																																																																																																						
enumeration	AED																																																																																																																																							
enumeration	AFN																																																																																																																																							
enumeration	ALL																																																																																																																																							
enumeration	AMD																																																																																																																																							
enumeration	ANG																																																																																																																																							
enumeration	AOA																																																																																																																																							
enumeration	ARS																																																																																																																																							
enumeration	AUD																																																																																																																																							
enumeration	AWG																																																																																																																																							
enumeration	AZN																																																																																																																																							
enumeration	BAM																																																																																																																																							
enumeration	BBD																																																																																																																																							
enumeration	BDT																																																																																																																																							
enumeration	BGN																																																																																																																																							
enumeration	BHD																																																																																																																																							
enumeration	BIF																																																																																																																																							
enumeration	BMD																																																																																																																																							
enumeration	BND																																																																																																																																							
enumeration	BOB																																																																																																																																							
enumeration	BOV																																																																																																																																							
enumeration	BRL																																																																																																																																							
enumeration	BSD																																																																																																																																							
enumeration	BTN																																																																																																																																							
enumeration	BWP																																																																																																																																							
enumeration	BYR																																																																																																																																							
enumeration	BZD																																																																																																																																							
enumeration	CAD																																																																																																																																							
enumeration	CDF																																																																																																																																							
enumeration	CHE																																																																																																																																							
enumeration	CHF																																																																																																																																							
enumeration	CHW																																																																																																																																							
enumeration	CLF																																																																																																																																							
enumeration	CLP																																																																																																																																							
enumeration	CNY																																																																																																																																							
enumeration	COP																																																																																																																																							
enumeration	COU																																																																																																																																							
enumeration	CRC																																																																																																																																							
enumeration	CUC																																																																																																																																							
enumeration	CUP																																																																																																																																							
enumeration	CVE																																																																																																																																							
enumeration	CZK																																																																																																																																							
enumeration	DJF																																																																																																																																							
enumeration	DKK																																																																																																																																							
enumeration	DOP																																																																																																																																							

enumeration	DZD
enumeration	EGP
enumeration	ERN
enumeration	ETB
enumeration	EUR
enumeration	FJD
enumeration	FKP
enumeration	GBP
enumeration	GEL
enumeration	GHS
enumeration	GIP
enumeration	GMD
enumeration	GNF
enumeration	GTQ
enumeration	GYD
enumeration	HKD
enumeration	HNL
enumeration	HRK
enumeration	HTG
enumeration	HUF
enumeration	IDR
enumeration	ILS
enumeration	INR
enumeration	IQD
enumeration	IRR
enumeration	ISK
enumeration	JMD
enumeration	JOD
enumeration	JPY
enumeration	KES
enumeration	KGS
enumeration	KHR
enumeration	KMF
enumeration	KPW
enumeration	KRW
enumeration	KWD
enumeration	KYD
enumeration	KZT
enumeration	LAK
enumeration	LBP
enumeration	LKR
enumeration	LRD
enumeration	LSL
enumeration	LYD
enumeration	MAD
enumeration	MDL

enumeration	MGA
enumeration	MKD
enumeration	MMK
enumeration	MNT
enumeration	MOP
enumeration	MRO
enumeration	MUR
enumeration	MVR
enumeration	MWK
enumeration	MXN
enumeration	MXV
enumeration	MYR
enumeration	MZN
enumeration	NAD
enumeration	NGN
enumeration	NIO
enumeration	NOK
enumeration	NPR
enumeration	NZD
enumeration	OMR
enumeration	PAB
enumeration	PEN
enumeration	PGK
enumeration	PHP
enumeration	PKR
enumeration	PLN
enumeration	PYG
enumeration	QAR
enumeration	RON
enumeration	RSD
enumeration	RUB
enumeration	RWF
enumeration	SAR
enumeration	SBD
enumeration	SCR
enumeration	SDG
enumeration	SEK
enumeration	SGD
enumeration	SHP
enumeration	SLL
enumeration	SOS
enumeration	SRD
enumeration	SSP
enumeration	STD
enumeration	SVC
enumeration	SYP

	enumeration SZL enumeration THB enumeration TJS enumeration TMT enumeration TND enumeration TOP enumeration TRY enumeration TTD enumeration TWD enumeration TZS enumeration UAH enumeration UGX enumeration USD enumeration USN enumeration UYI enumeration UYU enumeration UZS enumeration VEF enumeration VND enumeration VUV enumeration WST enumeration XAF enumeration XAG enumeration XAU enumeration XBA enumeration XBB enumeration XBC enumeration XBD enumeration XCD enumeration XDR enumeration XOF enumeration XPD enumeration XPF enumeration XPT enumeration XSU enumeration XTS enumeration XUA enumeration XXX enumeration YER enumeration ZAR enumeration ZMW enumeration ZWL
annotation	documentation Código de la moneda de acuerdo al ISO 4217
source	<xs:element name="CodigoMoneda" minOccurs="0"> <xs:annotation> <xs:documentation>Código de la moneda de acuerdo al ISO 4217</xs:documentation>

```
</xs:annotation>
<xs:simpleType>
  <xs:restriction base="xs:string">
    <xs:enumeration value="AED"/>
    <xs:enumeration value="AFN"/>
    <xs:enumeration value="ALL"/>
    <xs:enumeration value="AMD"/>
    <xs:enumeration value="ANG"/>
    <xs:enumeration value="AOA"/>
    <xs:enumeration value="ARS"/>
    <xs:enumeration value="AUD"/>
    <xs:enumeration value="AWG"/>
    <xs:enumeration value="AZN"/>
    <xs:enumeration value="BAM"/>
    <xs:enumeration value="BBD"/>
    <xs:enumeration value="BDT"/>
    <xs:enumeration value="BGN"/>
    <xs:enumeration value="BHD"/>
    <xs:enumeration value="BIF"/>
    <xs:enumeration value="BMD"/>
    <xs:enumeration value="BND"/>
    <xs:enumeration value="BOB"/>
    <xs:enumeration value="BOV"/>
    <xs:enumeration value="BRL"/>
    <xs:enumeration value="BSD"/>
    <xs:enumeration value="BTN"/>
    <xs:enumeration value="BWP"/>
    <xs:enumeration value="BYR"/>
    <xs:enumeration value="BZD"/>
    <xs:enumeration value="CAD"/>
    <xs:enumeration value="CDF"/>
    <xs:enumeration value="CHE"/>
    <xs:enumeration value="CHF"/>
    <xs:enumeration value="CHW"/>
    <xs:enumeration value="CLF"/>
    <xs:enumeration value="CLP"/>
    <xs:enumeration value="CNY"/>
    <xs:enumeration value="COP"/>
    <xs:enumeration value="COU"/>
    <xs:enumeration value="CRC"/>
    <xs:enumeration value="CUC"/>
    <xs:enumeration value="CUP"/>
    <xs:enumeration value="CVE"/>
    <xs:enumeration value="CZK"/>
    <xs:enumeration value="DJF"/>
    <xs:enumeration value="DKK"/>
    <xs:enumeration value="DOP"/>
    <xs:enumeration value="DZD"/>
    <xs:enumeration value="EGP"/>
    <xs:enumeration value="ERN"/>
    <xs:enumeration value="ETB"/>
    <xs:enumeration value="EUR"/>
    <xs:enumeration value="FJD"/>
    <xs:enumeration value="FKP"/>
    <xs:enumeration value="GBP"/>
    <xs:enumeration value="GEL"/>
  </xs:restriction>
</xs:simpleType>
</xs:annotation>
```

<xs:enumeration value="GHS"/>
<xs:enumeration value="GIP"/>
<xs:enumeration value="GMD"/>
<xs:enumeration value="GNF"/>
<xs:enumeration value="GTQ"/>
<xs:enumeration value="GYD"/>
<xs:enumeration value="HKD"/>
<xs:enumeration value="HNL"/>
<xs:enumeration value="HRK"/>
<xs:enumeration value="HTG"/>
<xs:enumeration value="HUF"/>
<xs:enumeration value="IDR"/>
<xs:enumeration value="ILS"/>
<xs:enumeration value="INR"/>
<xs:enumeration value="IQD"/>
<xs:enumeration value="IRR"/>
<xs:enumeration value="ISK"/>
<xs:enumeration value="JMD"/>
<xs:enumeration value="JOD"/>
<xs:enumeration value="JPY"/>
<xs:enumeration value="KES"/>
<xs:enumeration value="KGS"/>
<xs:enumeration value="KHR"/>
<xs:enumeration value="KMF"/>
<xs:enumeration value="KPW"/>
<xs:enumeration value="KRW"/>
<xs:enumeration value="KWD"/>
<xs:enumeration value="KYD"/>
<xs:enumeration value="KZT"/>
<xs:enumeration value="LAK"/>
<xs:enumeration value="LBP"/>
<xs:enumeration value="LKR"/>
<xs:enumeration value="LRD"/>
<xs:enumeration value="LSL"/>
<xs:enumeration value="LYD"/>
<xs:enumeration value="MAD"/>
<xs:enumeration value="MDL"/>
<xs:enumeration value="MGA"/>
<xs:enumeration value="MKD"/>
<xs:enumeration value="MMK"/>
<xs:enumeration value="MNT"/>
<xs:enumeration value="MOP"/>
<xs:enumeration value="MRO"/>
<xs:enumeration value="MUR"/>
<xs:enumeration value="MVR"/>
<xs:enumeration value="MWK"/>
<xs:enumeration value="MXN"/>
<xs:enumeration value="MXV"/>
<xs:enumeration value="MYR"/>
<xs:enumeration value="MZN"/>
<xs:enumeration value="NAD"/>
<xs:enumeration value="NGN"/>
<xs:enumeration value="NIO"/>
<xs:enumeration value="NOK"/>
<xs:enumeration value="NPR"/>
<xs:enumeration value="NZD"/>

<xs:enumeration value="OMR"/>
<xs:enumeration value="PAB"/>
<xs:enumeration value="PEN"/>
<xs:enumeration value="PGK"/>
<xs:enumeration value="PHP"/>
<xs:enumeration value="PKR"/>
<xs:enumeration value="PLN"/>
<xs:enumeration value="PYG"/>
<xs:enumeration value="QAR"/>
<xs:enumeration value="RON"/>
<xs:enumeration value="RSD"/>
<xs:enumeration value="RUB"/>
<xs:enumeration value="RWF"/>
<xs:enumeration value="SAR"/>
<xs:enumeration value="SBD"/>
<xs:enumeration value="SCR"/>
<xs:enumeration value="SDG"/>
<xs:enumeration value="SEK"/>
<xs:enumeration value="SGD"/>
<xs:enumeration value="SHP"/>
<xs:enumeration value="SLL"/>
<xs:enumeration value="SOS"/>
<xs:enumeration value="SRD"/>
<xs:enumeration value="SSP"/>
<xs:enumeration value="STD"/>
<xs:enumeration value="SVC"/>
<xs:enumeration value="SYP"/>
<xs:enumeration value="SZL"/>
<xs:enumeration value="THB"/>
<xs:enumeration value="TJS"/>
<xs:enumeration value="TMT"/>
<xs:enumeration value="TND"/>
<xs:enumeration value="TOP"/>
<xs:enumeration value="TRY"/>
<xs:enumeration value="TTD"/>
<xs:enumeration value="TWD"/>
<xs:enumeration value="TZS"/>
<xs:enumeration value="UAH"/>
<xs:enumeration value="UGX"/>
<xs:enumeration value="USD"/>
<xs:enumeration value="USN"/>
<xs:enumeration value="UYI"/>
<xs:enumeration value="UYU"/>
<xs:enumeration value="UZS"/>
<xs:enumeration value="VEF"/>
<xs:enumeration value="VND"/>
<xs:enumeration value="VUV"/>
<xs:enumeration value="WST"/>
<xs:enumeration value="XAF"/>
<xs:enumeration value="XAG"/>
<xs:enumeration value="XAU"/>
<xs:enumeration value="XBA"/>
<xs:enumeration value="XBB"/>
<xs:enumeration value="XBC"/>
<xs:enumeration value="XBD"/>
<xs:enumeration value="XCD"/>

	<pre> <xs:enumeration value="XDR"/> <xs:enumeration value="XOF"/> <xs:enumeration value="XPD"/> <xs:enumeration value="XPF"/> <xs:enumeration value="XPT"/> <xs:enumeration value="XSU"/> <xs:enumeration value="XTS"/> <xs:enumeration value="XUA"/> <xs:enumeration value="XXX"/> <xs:enumeration value="YER"/> <xs:enumeration value="ZAR"/> <xs:enumeration value="ZMW"/> <xs:enumeration value="ZWL"/> </xs:restriction> </xs:simpleType> </xs:element> </pre>
--	---------------------------------------------------------------------------------------------------------------------------------------------------------------------------------------------------------------------------------------------------------------------------------------------------------------------------------------------------------------------------------------------------------------------------------------------------------------------------------------------------------------------------------------------------------------------

element **FacturaElectronica/ResumenFactura/TipoCambio**

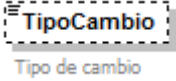
diagram										
namespace	https://www.hacienda.go.cr/ATV/docs/esquemas/2016/v4/facturaElectronica									
type	DecimalDineroType									
properties	minOcc 0 maxOcc 1 content simple									
facets	<table border="0"> <tr> <td>Kind</td> <td>Value</td> <td>Annotation</td> </tr> <tr> <td>totalDigits</td> <td>18</td> <td></td> </tr> <tr> <td>fractionDigits</td> <td>5</td> <td></td> </tr> </table>	Kind	Value	Annotation	totalDigits	18		fractionDigits	5	
Kind	Value	Annotation								
totalDigits	18									
fractionDigits	5									
annotation	documentation Tipo de cambio									
source	<pre> <xs:element name="TipoCambio" type="DecimalDineroType" minOccurs="0"> <xs:annotation> <xs:documentation>Tipo de cambio</xs:documentation> </xs:annotation> </xs:element> </pre>									

element **FacturaElectronica/ResumenFactura/TotalServGravados**

diagram							
namespace	https://www.hacienda.go.cr/ATV/docs/esquemas/2016/v4/facturaElectronica						
type	DecimalDineroType						
properties	minOcc 0 maxOcc 1 content simple						
facets	<table border="0"> <tr> <td>Kind</td> <td>Value</td> <td>Annotation</td> </tr> <tr> <td>totalDigits</td> <td>18</td> <td></td> </tr> </table>	Kind	Value	Annotation	totalDigits	18	
Kind	Value	Annotation					
totalDigits	18						

	fractionDigits 5
annotation	documentation Total de los servicios gravados con IV
source	<pre><xs:element name="TotalServGravados" type="DecimalDineroType" minOccurs="0"> <xs:annotation> <xs:documentation>Total de los servicios gravados con IV</xs:documentation> </xs:annotation> </xs:element></pre>

element **FacturaElectronica/ResumenFactura/TotalServExentos**

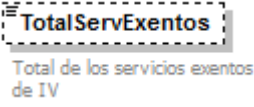
diagram										
namespace	https://www.hacienda.go.cr/ATV/docs/esquemas/2016/v4/facturaElectronica									
type	DecimalDineroType									
properties	minOcc 0 maxOcc 1 content simple									
facets	<table border="1"> <thead> <tr> <th>Kind</th> <th>Value</th> <th>Annotation</th> </tr> </thead> <tbody> <tr> <td>totalDigits</td> <td>18</td> <td></td> </tr> <tr> <td>fractionDigits</td> <td>5</td> <td></td> </tr> </tbody> </table>	Kind	Value	Annotation	totalDigits	18		fractionDigits	5	
Kind	Value	Annotation								
totalDigits	18									
fractionDigits	5									
annotation	documentation Total de los servicios exentos de IV									
source	<pre><xs:element name="TotalServExentos" type="DecimalDineroType" minOccurs="0"> <xs:annotation> <xs:documentation>Total de los servicios exentos de IV</xs:documentation> </xs:annotation> </xs:element></pre>									

element **FacturaElectronica/ResumenFactura/TotalMercanciasGravadas**

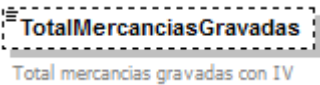
diagram										
namespace	https://www.hacienda.go.cr/ATV/docs/esquemas/2016/v4/facturaElectronica									
type	DecimalDineroType									
properties	minOcc 0 maxOcc 1 content simple									
facets	<table border="1"> <thead> <tr> <th>Kind</th> <th>Value</th> <th>Annotation</th> </tr> </thead> <tbody> <tr> <td>totalDigits</td> <td>18</td> <td></td> </tr> <tr> <td>fractionDigits</td> <td>5</td> <td></td> </tr> </tbody> </table>	Kind	Value	Annotation	totalDigits	18		fractionDigits	5	
Kind	Value	Annotation								
totalDigits	18									
fractionDigits	5									
annotation	documentation Total mercancias gravadas con IV									
source	<pre><xs:element name="TotalMercanciasGravadas" type="DecimalDineroType" minOccurs="0"> <xs:annotation> <xs:documentation>Total mercancias gravadas con IV</xs:documentation> </xs:annotation> </xs:element></pre>									

element **FacturaElectronica/ResumenFactura/TotalMercanciasExentas**

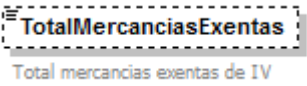
diagram										
namespace	https://www.hacienda.go.cr/ATV/docs/esquemas/2016/v4/facturaElectronica									
type	DecimalDineroType									
properties	minOcc 0 maxOcc 1 content simple									
facets	<table border="1"> <thead> <tr> <th>Kind</th> <th>Value</th> <th>Annotation</th> </tr> </thead> <tbody> <tr> <td>totalDigits</td> <td>18</td> <td></td> </tr> <tr> <td>fractionDigits</td> <td>5</td> <td></td> </tr> </tbody> </table>	Kind	Value	Annotation	totalDigits	18		fractionDigits	5	
Kind	Value	Annotation								
totalDigits	18									
fractionDigits	5									
annotation	documentation Total mercancías exentas de IV									
source	<pre><xs:element name="TotalMercanciasExentas" type="DecimalDineroType" minOccurs="0"> <xs:annotation> <xs:documentation>Total mercancías exentas de IV</xs:documentation> </xs:annotation> </xs:element></pre>									

element **FacturaElectronica/ResumenFactura/TotalGravado**

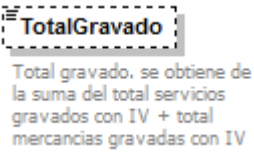
diagram										
namespace	https://www.hacienda.go.cr/ATV/docs/esquemas/2016/v4/facturaElectronica									
type	DecimalDineroType									
properties	minOcc 0 maxOcc 1 content simple									
facets	<table border="1"> <thead> <tr> <th>Kind</th> <th>Value</th> <th>Annotation</th> </tr> </thead> <tbody> <tr> <td>totalDigits</td> <td>18</td> <td></td> </tr> <tr> <td>fractionDigits</td> <td>5</td> <td></td> </tr> </tbody> </table>	Kind	Value	Annotation	totalDigits	18		fractionDigits	5	
Kind	Value	Annotation								
totalDigits	18									
fractionDigits	5									
annotation	documentation Total gravado. se obtiene de la suma del total servicios gravados con IV + total mercancías gravadas con IV									
source	<pre><xs:element name="TotalGravado" type="DecimalDineroType" minOccurs="0"> <xs:annotation> <xs:documentation>Total gravado. se obtiene de la suma del total servicios gravados con IV + total mercancías gravadas con IV</xs:documentation> </xs:annotation> </xs:element></pre>									

element **FacturaElectronica/ResumenFactura/TotalExento**

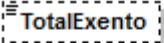
diagram	 <p>Total Exento, se obtiene de la suma de los campos total servicios exentos IV mas total mercancias exentas IV</p>									
namespace	https://www.hacienda.go.cr/ATV/docs/esquemas/2016/v4/facturaElectronica									
type	DecimalDineroType									
properties	minOcc 0 maxOcc 1 content simple									
facets	<table border="0"> <tr> <td>Kind</td> <td>Value</td> <td>Annotation</td> </tr> <tr> <td>totalDigits</td> <td>18</td> <td></td> </tr> <tr> <td>fractionDigits</td> <td>5</td> <td></td> </tr> </table>	Kind	Value	Annotation	totalDigits	18		fractionDigits	5	
Kind	Value	Annotation								
totalDigits	18									
fractionDigits	5									
annotation	documentation Total Exento, se obtiene de la suma de los campos total servicios exentos IV mas total mercancias exentas IV									
source	<pre><xs:element name="TotalExento" type="DecimalDineroType" minOccurs="0"> <xs:annotation> <xs:documentation>Total Exento, se obtiene de la suma de los campos total servicios exentos IV mas total mercancias exentas IV</xs:documentation> </xs:annotation> </xs:element></pre>									

element **FacturaElectronica/ResumenFactura/TotalVenta**

diagram	 <p>Se obtiene de la suma de los campos total gravado más total exento</p>									
namespace	https://www.hacienda.go.cr/ATV/docs/esquemas/2016/v4/facturaElectronica									
type	DecimalDineroType									
properties	content simple									
facets	<table border="0"> <tr> <td>Kind</td> <td>Value</td> <td>Annotation</td> </tr> <tr> <td>totalDigits</td> <td>18</td> <td></td> </tr> <tr> <td>fractionDigits</td> <td>5</td> <td></td> </tr> </table>	Kind	Value	Annotation	totalDigits	18		fractionDigits	5	
Kind	Value	Annotation								
totalDigits	18									
fractionDigits	5									
annotation	documentation Se obtiene de la suma de los campos total gravado más total exento									
source	<pre><xs:element name="TotalVenta" type="DecimalDineroType"> <xs:annotation> <xs:documentation>Se obtiene de la suma de los campos total gravado más total exento</xs:documentation> </xs:annotation> </xs:element></pre>									

element **FacturaElectronica/ResumenFactura/TotalDescuentos**

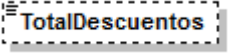
diagram	 <p>Se obtiene de la suma de todos los campo de monto de descuento concedido</p>									
namespace	https://www.hacienda.go.cr/ATV/docs/esquemas/2016/v4/facturaElectronica									
type	DecimalDineroType									
properties	minOcc 0 maxOcc 1 content simple									
facets	<table border="0"> <tr> <td>Kind</td> <td>Value</td> <td>Annotation</td> </tr> <tr> <td>totalDigits</td> <td>18</td> <td></td> </tr> <tr> <td>fractionDigits</td> <td>5</td> <td></td> </tr> </table>	Kind	Value	Annotation	totalDigits	18		fractionDigits	5	
Kind	Value	Annotation								
totalDigits	18									
fractionDigits	5									
annotation	documentation Se obtiene de la suma de todos los campo de monto de descuento concedido									
source	<pre><xs:element name="TotalDescuentos" type="DecimalDineroType" minOccurs="0"> <xs:annotation> <xs:documentation>Se obtiene de la suma de todos los campo de monto de descuento concedido</xs:documentation> </xs:annotation> </xs:element></pre>									

element **FacturaElectronica/ResumenFactura/TotalVentaNeta**

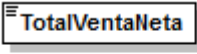
diagram	 <p>Se obtiene de la resta de los campos total venta menos total descuento</p>									
namespace	https://www.hacienda.go.cr/ATV/docs/esquemas/2016/v4/facturaElectronica									
type	DecimalDineroType									
properties	content simple									
facets	<table border="0"> <tr> <td>Kind</td> <td>Value</td> <td>Annotation</td> </tr> <tr> <td>totalDigits</td> <td>18</td> <td></td> </tr> <tr> <td>fractionDigits</td> <td>5</td> <td></td> </tr> </table>	Kind	Value	Annotation	totalDigits	18		fractionDigits	5	
Kind	Value	Annotation								
totalDigits	18									
fractionDigits	5									
annotation	documentation Se obtiene de la resta de los campos total venta menos total descuento									
source	<pre><xs:element name="TotalVentaNeta" type="DecimalDineroType"> <xs:annotation> <xs:documentation>Se obtiene de la resta de los campos total venta menos total descuento</xs:documentation> </xs:annotation> </xs:element></pre>									

element **FacturaElectronica/ResumenFactura/TotalImpuesto**

<p>diagram</p>	<p>TotalImpuesto 0..∞ Se obtiene de la suma de todos campos monto del impuesto</p> <p>ImpuestoType 1..∞</p> <p>Codigo Código del impuesto: 01 Impuesto General sobre las ventas, 02 Impuesto Selectivo de Consumo, 03 Impuesto único a los combustivos, 04 Impuesto específico de bebidas alcohólicas, 05 Impuesto específico sobre las bebidas envasadas sin contenido alcohólico y jabones de tocador, 06 Impuesto a los productos de tabaco, 07 Servicios, 99 Otros, 08 Impuesto General a las Ventas Diplomáticos, 09 Impuesto General sobre Ventas compras autorizadas, 10 Impuesto General sobre las ventas instituciones públicas y otros organismos, 11 Impuesto Selectivo de consumo compras autorizadas</p> <p>Tarifa 1..∞ Tarifa del impuesto</p> <p>Monto Se obtiene de la multiplicación del campo subtotal por la tarifa del impuesto</p>
<p>namespace</p>	<p>https://www.hacienda.go.cr/ATV/docs/esquemas/2016/v4/facturaElectronica</p>
<p>type</p>	<p>ImpuestoType</p>
<p>properties</p>	<p>minOcc 0 maxOcc unbounded content complex</p>
<p>children</p>	<p>Codigo Tarifa Monto</p>
<p>annotation</p>	<p>documentation Se obtiene de la suma de todos campos monto del impuesto</p>
<p>source</p>	<pre><xs:element name="TotalImpuesto" type="ImpuestoType" minOccurs="0" maxOccurs="unbounded"> <xs:annotation> <xs:documentation>Se obtiene de la suma de todos campos monto del impuesto</xs:documentation> </xs:annotation> </xs:element></pre>

element **FacturaElectronica/ResumenFactura/TotalComprobante**

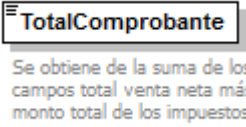
diagram	 <p>TotalComprobante Se obtiene de la suma de los campos total venta neta más monto total de los impuestos</p>									
namespace	https://www.hacienda.go.cr/ATV/docs/esquemas/2016/v4/facturaElectronica									
type	DecimalDineroType									
properties	content simple									
facets	<table border="1"> <thead> <tr> <th>Kind</th> <th>Value</th> <th>Annotation</th> </tr> </thead> <tbody> <tr> <td>totalDigits</td> <td>18</td> <td></td> </tr> <tr> <td>fractionDigits</td> <td>5</td> <td></td> </tr> </tbody> </table>	Kind	Value	Annotation	totalDigits	18		fractionDigits	5	
Kind	Value	Annotation								
totalDigits	18									
fractionDigits	5									
annotation	<p>documentation Se obtiene de la suma de los campos total venta neta más monto total de los impuestos</p>									
source	<pre><xs:element name="TotalComprobante" type="DecimalDineroType"> <xs:annotation> <xs:documentation>Se obtiene de la suma de los campos total venta neta más monto total de los impuestos</xs:documentation> </xs:annotation> </xs:element></pre>									

element **FacturaElectronica/InformacionReferencia**

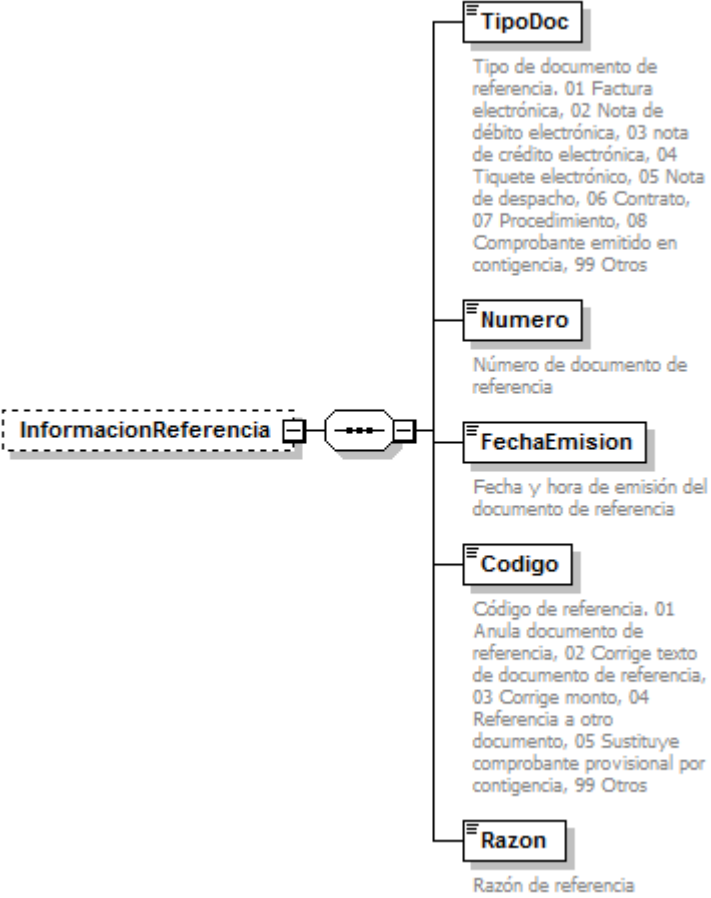
diagram	 <p>InformacionReferencia</p> <ul style="list-style-type: none"> TipoDoc: Tipo de documento de referencia. 01 Factura electrónica, 02 Nota de débito electrónica, 03 nota de crédito electrónica, 04 Tiquete electrónico, 05 Nota de despacho, 06 Contrato, 07 Procedimiento, 08 Comprobante emitido en contingencia, 99 Otros Numero: Número de documento de referencia FechaEmision: Fecha y hora de emisión del documento de referencia Codigo: Código de referencia. 01 Anula documento de referencia, 02 Corrige texto de documento de referencia, 03 Corrige monto, 04 Referencia a otro documento, 05 Sustituye comprobante provisional por contingencia, 99 Otros Razon: Razón de referencia
---------	--------------------------------------------------------------------------------------------------------------------------------------------------------------------------------------------------------------------------------------------------------------------------------------------------------------------------------------------------------------------------------------------------------------------------------------------------------------------------------------------------------------------------------------------------------------------------------------------------------------------------------------------------------------------------------------------------------------------------------------------------------------------------------------------------------------------------------------------------------------------------------------

namespace	https://www.hacienda.go.cr/ATV/docs/esquemas/2016/v4/facturaElectronica
properties	minOcc 0 maxOcc 1 content complex
children	TipoDoc Numero FechaEmision Codigo Razon
source	<pre> <xs:element name="InformacionReferencia" minOccurs="0"> <xs:complexType> <xs:sequence> <xs:element name="TipoDoc"> <xs:annotation> <xs:documentation>Tipo de documento de referencia. 01 Factura electrónica, 02 Nota de débito electrónica, 03 nota de crédito electrónica, 04 Tiquete electrónico, 05 Nota de despacho, 06 Contrato, 07 Procedimiento, 08 Comprobante emitido en contingencia, 99 Otros</xs:documentation> </xs:annotation> <xs:simpleType> <xs:restriction base="xs:string"> <xs:enumeration value="01"> <xs:annotation> <xs:documentation>Factura electrónica</xs:documentation> </xs:annotation> </xs:enumeration> <xs:enumeration value="02"> <xs:annotation> <xs:documentation>Nota de debido electrónica</xs:documentation> </xs:annotation> </xs:enumeration> <xs:enumeration value="03"> <xs:annotation> <xs:documentation>nota de crédito electrónica</xs:documentation> </xs:annotation> </xs:enumeration> <xs:enumeration value="04"> <xs:annotation> <xs:documentation>Tiquete electrónico</xs:documentation> </xs:annotation> </xs:enumeration> <xs:enumeration value="05"> <xs:annotation> <xs:documentation>Nota de despacho</xs:documentation> </xs:annotation> </xs:enumeration> <xs:enumeration value="06"> <xs:annotation> <xs:documentation>Contrato</xs:documentation> </xs:annotation> </xs:enumeration> <xs:enumeration value="07"> <xs:annotation> <xs:documentation>Procedimiento</xs:documentation> </xs:annotation> </xs:enumeration> <xs:enumeration value="08"> <xs:annotation> <xs:documentation>Comprobante emitido en contingencia</xs:documentation> </xs:annotation> </xs:enumeration> </xs:restriction> </xs:simpleType> </xs:element> </xs:sequence> </xs:complexType> </xs:element> </pre>

```

</xs:annotation>
</xs:enumeration>
<xs:enumeration value="99">
  <xs:annotation>
    <xs:documentation>Otros</xs:documentation>
  </xs:annotation>
</xs:enumeration>
</xs:restriction>
</xs:simpleType>
</xs:element>
<xs:element name="Numero">
  <xs:annotation>
    <xs:documentation>Número de documento de referencia</xs:documentation>
  </xs:annotation>
  <xs:simpleType>
    <xs:restriction base="xs:string">
      <xs:maxLength value="50"/>
    </xs:restriction>
  </xs:simpleType>
</xs:element>
<xs:element name="FechaEmision" type="xs:dateTime">
  <xs:annotation>
    <xs:documentation>Fecha y hora de emisión del documento de
referencia</xs:documentation>
  </xs:annotation>
</xs:element>
<xs:element name="Codigo">
  <xs:annotation>
    <xs:documentation>Código de referencia. 01 Anula documento de referencia, 02 Corrige
texto de documento de referencia, 03 Corrige monto, 04 Referencia a otro documento, 05
Sustituye comprobante provisional por contingencia, 99 Otros</xs:documentation>
  </xs:annotation>
  <xs:simpleType>
    <xs:restriction base="xs:string">
      <xs:enumeration value="01">
        <xs:annotation>
          <xs:documentation>Anula documento de referencia</xs:documentation>
        </xs:annotation>
      </xs:enumeration>
      <xs:enumeration value="02">
        <xs:annotation>
          <xs:documentation>Corrige texto de ocumento de referencia</xs:documentation>
        </xs:annotation>
      </xs:enumeration>
      <xs:enumeration value="03">
        <xs:annotation>
          <xs:documentation>Corrige monto</xs:documentation>
        </xs:annotation>
      </xs:enumeration>
      <xs:enumeration value="04">
        <xs:annotation>
          <xs:documentation>Referencia a otro documento</xs:documentation>
        </xs:annotation>
      </xs:enumeration>
      <xs:enumeration value="05">
        <xs:annotation>

```

```

<xs:documentation>Sustituye comprobante provisional por
contingencia</xs:documentation>
</xs:annotation>
</xs:enumeration>
<xs:enumeration value="99">
<xs:annotation>
<xs:documentation>Otros</xs:documentation>
</xs:annotation>
</xs:enumeration>
</xs:restriction>
</xs:simpleType>
</xs:element>
<xs:element name="Razon">
<xs:annotation>
<xs:documentation>Razón de referencia</xs:documentation>
</xs:annotation>
<xs:simpleType>
<xs:restriction base="xs:string">
<xs:maxLength value="180"/>
</xs:restriction>
</xs:simpleType>
</xs:element>
</xs:sequence>
</xs:complexType>
</xs:element>

```

element **FacturaElectronica/InformacionReferencia/TipoDoc**

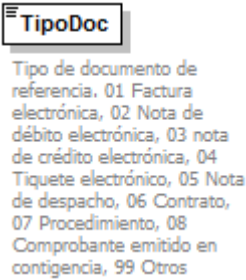
diagram			
namespace	https://www.hacienda.go.cr/ATV/docs/esquemas/2016/v4/facturaElectronica		
type	restriction of xs:string		
properties	content simple		
facets	Kind	Value	Annotation
	enumeration	01	documentation Factura electrónica
	enumeration	02	documentation Nota de debito electrónica
	enumeration	03	documentation nota de crédito electrónica
	enumeration	04	documentation Tiquete electrónico
	enumeration	05	documentation Nota de despacho
	enumeration	06	documentation Contrato
	enumeration	07	documentation Procedimiento

	enumeration 08 documentation Comprobante emitido en contingencia
	enumeration 99 documentation Otros
annotation	documentation Tipo de documento de referencia. 01 Factura electrónica, 02 Nota de débito electrónica, 03 nota de crédito electrónica, 04 Tiquete electrónico, 05 Nota de despacho, 06 Contrato, 07 Procedimiento, 08 Comprobante emitido en contingencia, 99 Otros
source	<pre> <xs:element name="TipoDoc"> <xs:annotation> <xs:documentation>Tipo de documento de referencia. 01 Factura electrónica, 02 Nota de débito electrónica, 03 nota de crédito electrónica, 04 Tiquete electrónico, 05 Nota de despacho, 06 Contrato, 07 Procedimiento, 08 Comprobante emitido en contingencia, 99 Otros</xs:documentation> </xs:annotation> <xs:simpleType> <xs:restriction base="xs:string"> <xs:enumeration value="01"> <xs:annotation> <xs:documentation>Factura electrónica</xs:documentation> </xs:annotation> </xs:enumeration> <xs:enumeration value="02"> <xs:annotation> <xs:documentation>Nota de debido electrónica</xs:documentation> </xs:annotation> </xs:enumeration> <xs:enumeration value="03"> <xs:annotation> <xs:documentation>nota de crédito electrónica</xs:documentation> </xs:annotation> </xs:enumeration> <xs:enumeration value="04"> <xs:annotation> <xs:documentation>Tiquete electrónico</xs:documentation> </xs:annotation> </xs:enumeration> <xs:enumeration value="05"> <xs:annotation> <xs:documentation>Nota de despacho</xs:documentation> </xs:annotation> </xs:enumeration> <xs:enumeration value="06"> <xs:annotation> <xs:documentation>Contrato</xs:documentation> </xs:annotation> </xs:enumeration> <xs:enumeration value="07"> <xs:annotation> <xs:documentation>Procedimiento</xs:documentation> </xs:annotation> </xs:enumeration> <xs:enumeration value="08"> <xs:annotation> <xs:documentation>Comprobante emitido en contingencia</xs:documentation> </xs:annotation> </xs:enumeration> </xs:restriction> </xs:simpleType> </xs:element> </pre>

	<pre> <xs:enumeration value="99"> <xs:annotation> <xs:documentation>Otros</xs:documentation> </xs:annotation> </xs:enumeration> </xs:restriction> </xs:simpleType> </xs:element> </pre>
--	-------------------------------------------------------------------------------------------------------------------------------------------------------------------------------------------------------------------------------------------------------

element **FacturaElectronica/InformacionReferencia/Numero**

diagram							
namespace	https://www.hacienda.go.cr/ATV/docs/esquemas/2016/v4/facturaElectronica						
type	restriction of xs:string						
properties	content simple						
facets	<table border="1"> <thead> <tr> <th>Kind</th> <th>Value</th> <th>Annotation</th> </tr> </thead> <tbody> <tr> <td>maxLength</td> <td>50</td> <td></td> </tr> </tbody> </table>	Kind	Value	Annotation	maxLength	50	
Kind	Value	Annotation					
maxLength	50						
annotation	documentation Número de documento de referencia						
source	<pre> <xs:element name="Numero"> <xs:annotation> <xs:documentation>Número de documento de referencia</xs:documentation> </xs:annotation> <xs:simpleType> <xs:restriction base="xs:string"> <xs:maxLength value="50"/> </xs:restriction> </xs:simpleType> </xs:element> </pre>						

element **FacturaElectronica/InformacionReferencia/FechaEmision**

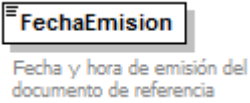
diagram	
namespace	https://www.hacienda.go.cr/ATV/docs/esquemas/2016/v4/facturaElectronica
type	xs:dateTime
properties	content simple
annotation	documentation Fecha y hora de emisión del documento de referencia
source	<pre> <xs:element name="FechaEmision" type="xs:dateTime"> <xs:annotation> <xs:documentation>Fecha y hora de emisión del documento de referencia</xs:documentation> </xs:annotation> </xs:element> </pre>

element **FacturaElectronica/InformacionReferencia/Codigo**

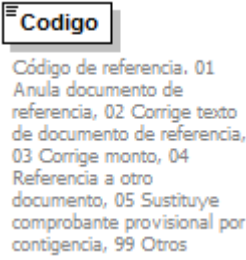
diagram																						
namespace	https://www.hacienda.go.cr/ATV/docs/esquemas/2016/v4/facturaElectronica																					
type	restriction of xs:string																					
properties	content simple																					
facets	<table border="1"> <thead> <tr> <th>Kind</th> <th>Value</th> <th>Annotation</th> </tr> </thead> <tbody> <tr> <td>enumeration</td> <td>01</td> <td>documentation Anula documento de referencia</td> </tr> <tr> <td>enumeration</td> <td>02</td> <td>documentation Corrige texto de ocumento de referencia</td> </tr> <tr> <td>enumeration</td> <td>03</td> <td>documentation Corrige monto</td> </tr> <tr> <td>enumeration</td> <td>04</td> <td>documentation Referencia a otro documento</td> </tr> <tr> <td>enumeration</td> <td>05</td> <td>documentation Sustituye comprobante provisional por contingencia</td> </tr> <tr> <td>enumeration</td> <td>99</td> <td>documentation Otros</td> </tr> </tbody> </table>	Kind	Value	Annotation	enumeration	01	documentation Anula documento de referencia	enumeration	02	documentation Corrige texto de ocumento de referencia	enumeration	03	documentation Corrige monto	enumeration	04	documentation Referencia a otro documento	enumeration	05	documentation Sustituye comprobante provisional por contingencia	enumeration	99	documentation Otros
Kind	Value	Annotation																				
enumeration	01	documentation Anula documento de referencia																				
enumeration	02	documentation Corrige texto de ocumento de referencia																				
enumeration	03	documentation Corrige monto																				
enumeration	04	documentation Referencia a otro documento																				
enumeration	05	documentation Sustituye comprobante provisional por contingencia																				
enumeration	99	documentation Otros																				
annotation	documentation Código de referencia. 01 Anula documento de referencia, 02 Corrige texto de documento de referencia, 03 Corrige monto, 04 Referencia a otro documento, 05 Sustituye comprobante provisional por contingencia, 99 Otros																					
source	<pre> <xs:element name="Codigo"> <xs:annotation> <xs:documentation>Código de referencia. 01 Anula documento de referencia, 02 Corrige texto de documento de referencia, 03 Corrige monto, 04 Referencia a otro documento, 05 Sustituye comprobante provisional por contingencia, 99 Otros</xs:documentation> </xs:annotation> <xs:simpleType> <xs:restriction base="xs:string"> <xs:enumeration value="01"> <xs:annotation> <xs:documentation>Anula documento de referencia</xs:documentation> </xs:annotation> </xs:enumeration> <xs:enumeration value="02"> <xs:annotation> <xs:documentation>Corrige texto de ocumento de referencia</xs:documentation> </xs:annotation> </xs:enumeration> <xs:enumeration value="03"> <xs:annotation> <xs:documentation>Corrige monto</xs:documentation> </xs:annotation> </xs:enumeration> <xs:enumeration value="04"> <xs:annotation> <xs:documentation>Referencia a otro documento</xs:documentation> </xs:annotation> </xs:enumeration> </xs:restriction> </xs:simpleType> </xs:element> </pre>																					

```

</xs:annotation>
</xs:enumeration>
<xs:enumeration value="05">
  <xs:annotation>
    <xs:documentation>Sustituye comprobante provisional por contingencia</xs:documentation>
  </xs:annotation>
</xs:enumeration>
<xs:enumeration value="99">
  <xs:annotation>
    <xs:documentation>Otros</xs:documentation>
  </xs:annotation>
</xs:enumeration>
</xs:restriction>
</xs:simpleType>
</xs:element>

```

element **FacturaElectronica/InformacionReferencia/Razon**

diagram							
namespace	https://www.hacienda.go.cr/ATV/docs/esquemas/2016/v4/facturaElectronica						
type	restriction of xs:string						
properties	content simple						
facets	<table border="1"> <thead> <tr> <th>Kind</th> <th>Value</th> <th>Annotation</th> </tr> </thead> <tbody> <tr> <td>maxLength</td> <td>180</td> <td></td> </tr> </tbody> </table>	Kind	Value	Annotation	maxLength	180	
Kind	Value	Annotation					
maxLength	180						
annotation	documentation Razón de referencia						
source	<pre> <xs:element name="Razon"> <xs:annotation> <xs:documentation>Razón de referencia</xs:documentation> </xs:annotation> <xs:simpleType> <xs:restriction base="xs:string"> <xs:maxLength value="180"/> </xs:restriction> </xs:simpleType> </xs:element> </pre>						

element **FacturaElectronica/Normativa**

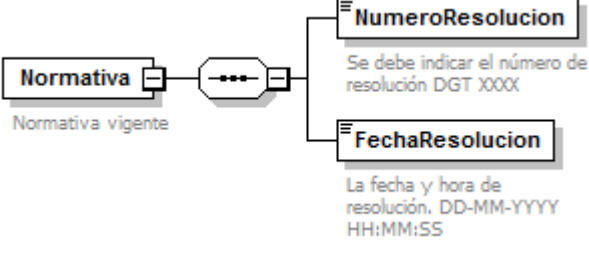
diagram	
namespace	https://www.hacienda.go.cr/ATV/docs/esquemas/2016/v4/facturaElectronica

properties	content complex
children	NumeroResolucion FechaResolucion
annotation	documentation Normativa vigente
source	<pre> <xs:element name="Normativa"> <xs:annotation> <xs:documentation>Normativa vigente</xs:documentation> </xs:annotation> <xs:complexType> <xs:sequence> <xs:element name="NumeroResolucion"> <xs:annotation> <xs:documentation>Se debe indicar el número de resolución DGT XXXXXXXX</xs:documentation> </xs:annotation> <xs:simpleType> <xs:restriction base="xs:string"> <xs:maxLength value="13"/> </xs:restriction> </xs:simpleType> </xs:element> <xs:element name="FechaResolucion"> <xs:annotation> <xs:documentation>La fecha y hora de resolución. DD-MM-YYYY HH:MM:SS</xs:documentation> </xs:annotation> <xs:simpleType> <xs:restriction base="xs:string"> <xs:maxLength value="20"/> </xs:restriction> </xs:simpleType> </xs:element> </xs:sequence> </xs:complexType> </xs:element> </pre>

element **FacturaElectronica/Normativa/NumeroResolucion**

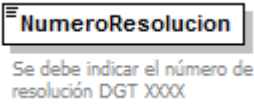
diagram							
namespace	https://www.hacienda.go.cr/ATV/docs/esquemas/2016/v4/facturaElectronica						
type	restriction of xs:string						
properties	content simple						
facets	<table border="0"> <tr> <td>Kind</td> <td>Value</td> <td>Annotation</td> </tr> <tr> <td>maxLength</td> <td>13</td> <td></td> </tr> </table>	Kind	Value	Annotation	maxLength	13	
Kind	Value	Annotation					
maxLength	13						
annotation	documentation Se debe indicar el número de resolución DGT XXXX						
source	<pre> <xs:element name="NumeroResolucion"> <xs:annotation> <xs:documentation>Se debe indicar el número de resolución DGT XXXX</xs:documentation> </pre>						

	<pre> </xs:annotation> <xs:simpleType> <xs:restriction base="xs:string"> <xs:maxLength value="13"/> </xs:restriction> </xs:simpleType> </xs:element> </pre>
--	---------------------------------------------------------------------------------------------------------------------------------------------------------------------------------------------------------------

element FacturaElectronica/Normativa/FechaResolucion

diagram							
namespace	https://www.hacienda.go.cr/ATV/docs/esquemas/2016/v4/facturaElectronica						
type	restriction of xs:string						
properties	content simple						
facets	<table border="1"> <thead> <tr> <th>Kind</th> <th>Value</th> <th>Annotation</th> </tr> </thead> <tbody> <tr> <td>maxLength</td> <td>20</td> <td></td> </tr> </tbody> </table>	Kind	Value	Annotation	maxLength	20	
Kind	Value	Annotation					
maxLength	20						
annotation	documentation La fecha y hora de resolución. DD-MM-YYYY HH:MM:SS						
source	<pre> <xs:element name="FechaResolucion"> <xs:annotation> <xs:documentation>La fecha y hora de resolución. DD-MM-YYYY HH:MM:SS</xs:documentation> </xs:annotation> <xs:simpleType> <xs:restriction base="xs:string"> <xs:maxLength value="20"/> </xs:restriction> </xs:simpleType> </xs:element> </pre>						

element FacturaElectronica/Otros

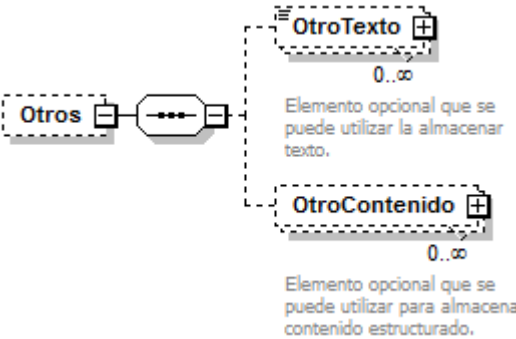
diagram							
namespace	https://www.hacienda.go.cr/ATV/docs/esquemas/2016/v4/facturaElectronica						
properties	<table border="1"> <tbody> <tr> <td>minOcc</td> <td>0</td> </tr> <tr> <td>maxOcc</td> <td>1</td> </tr> <tr> <td>content</td> <td>complex</td> </tr> </tbody> </table>	minOcc	0	maxOcc	1	content	complex
minOcc	0						
maxOcc	1						
content	complex						

children	OtroTexto OtroContenido
source	<pre> <xs:element name="Otros" minOccurs="0"> <xs:complexType> <xs:sequence> <xs:element name="OtroTexto" minOccurs="0" maxOccurs="unbounded"> <xs:annotation> <xs:documentation>Elemento opcional que se puede utilizar la almacenar texto.</xs:documentation> </xs:annotation> <xs:complexType> <xs:simpleContent> <xs:extension base="xs:string"> <xs:attribute name="codigo" type="xs:string"> <xs:annotation> <xs:documentation>Código opcional para facilitar la identificación del elemento.</xs:documentation> </xs:annotation> </xs:attribute> </xs:extension> </xs:simpleContent> </xs:complexType> </xs:element> <xs:element name="OtroContenido" minOccurs="0" maxOccurs="unbounded"> <xs:annotation> <xs:documentation>Elemento opcional que se puede utilizar para almacenar contenido estructurado.</xs:documentation> </xs:annotation> <xs:complexType> <xs:sequence> <xs:any namespace="##other" processContents="lax"/> </xs:sequence> <xs:attribute name="codigo" type="xs:string"> <xs:annotation> <xs:documentation>Código opcional para facilitar la identificación del elemento.</xs:documentation> </xs:annotation> </xs:attribute> </xs:complexType> </xs:element> </xs:sequence> </xs:complexType> </xs:element> </pre>

element **FacturaElectronica/Otros/OtroTexto**

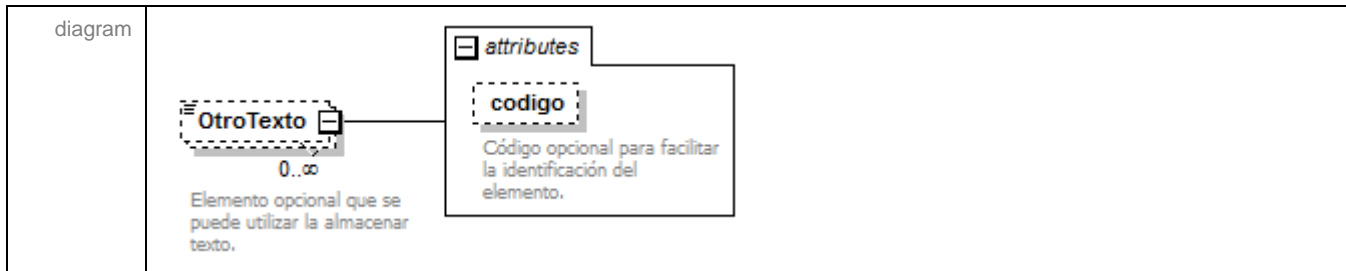

namespace	https://www.hacienda.go.cr/ATV/docs/esquemas/2016/v4/facturaElectronica					
type	extension of xs:string					
properties	minOcc	0				
	maxOcc	unbounded				
	content	complex				
attributes	Name	Type	Use	Default	Fixed	Annotation
	codigo	xs:string				documentation Código opcional para facilitar la identificación del elemento.
annotation	documentation Elemento opcional que se puede utilizar la almacenar texto.					
source	<pre> <xs:element name="OtroTexto" minOccurs="0" maxOccurs="unbounded"> <xs:annotation> <xs:documentation>Elemento opcional que se puede utilizar la almacenar texto.</xs:documentation> </xs:annotation> <xs:complexType> <xs:simpleContent> <xs:extension base="xs:string"> <xs:attribute name="codigo" type="xs:string"> <xs:annotation> <xs:documentation>Código opcional para facilitar la identificación del elemento.</xs:documentation> </xs:annotation> </xs:attribute> </xs:extension> </xs:simpleContent> </xs:complexType> </xs:element> </pre>					

attribute **FacturaElectronica/Otros/OtroTexto/@codigo**

type	xs:string
annotation	documentation Código opcional para facilitar la identificación del elemento.
source	<pre> <xs:attribute name="codigo" type="xs:string"> <xs:annotation> <xs:documentation>Código opcional para facilitar la identificación del elemento.</xs:documentation> </xs:annotation> </xs:attribute> </pre>

element **FacturaElectronica/Otros/OtroContenido**

diagram													
namespace	https://www.hacienda.go.cr/ATV/docs/esquemas/2016/v4/facturaElectronica												
properties	minOcc 0 maxOcc unbounded content complex												
attributes	<table border="1"> <thead> <tr> <th>Name</th> <th>Type</th> <th>Use</th> <th>Default</th> <th>Fixed</th> <th>Annotation documentation</th> </tr> </thead> <tbody> <tr> <td>codigo</td> <td>xs:string</td> <td></td> <td></td> <td></td> <td>Código opcional para facilitar la identificación del elemento.</td> </tr> </tbody> </table>	Name	Type	Use	Default	Fixed	Annotation documentation	codigo	xs:string				Código opcional para facilitar la identificación del elemento.
Name	Type	Use	Default	Fixed	Annotation documentation								
codigo	xs:string				Código opcional para facilitar la identificación del elemento.								
annotation	documentation Elemento opcional que se puede utilizar para almacenar contenido estructurado.												
source	<pre> <xs:element name="OtroContenido" minOccurs="0" maxOccurs="unbounded"> <xs:annotation> <xs:documentation>Elemento opcional que se puede utilizar para almacenar contenido estructurado.</xs:documentation> </xs:annotation> <xs:complexType> <xs:sequence> <xs:any namespace="##other" processContents="lax"/> </xs:sequence> <xs:attribute name="codigo" type="xs:string"> <xs:annotation> <xs:documentation>Código opcional para facilitar la identificación del elemento.</xs:documentation> </xs:annotation> </xs:attribute> </xs:complexType> </xs:element> </pre>												

attribute **FacturaElectronica/Otros/OtroContenido/@codigo**

type	xs:string
annotation	documentation Código opcional para facilitar la identificación del elemento.
source	<pre> <xs:attribute name="codigo" type="xs:string"> <xs:annotation> <xs:documentation>Código opcional para facilitar la identificación del elemento.</xs:documentation> </xs:annotation> </xs:attribute> </pre>

complexType CodigoType

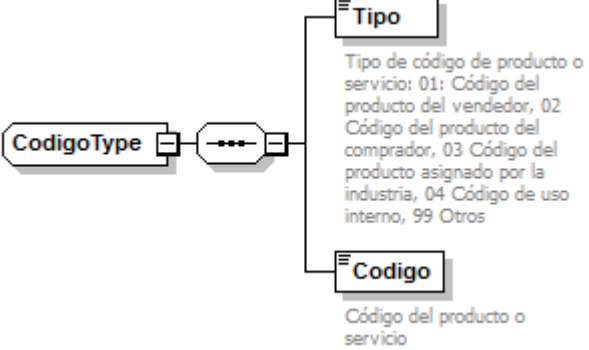
diagram	
namespace	https://www.hacienda.go.cr/ATV/docs/esquemas/2016/v4/facturaElectronica
children	Tipo Codigo
used by	element FacturaElectronica/DetalleServicio/LineaDetalle/Codigo
source	<pre> <xs:complexType name="CodigoType"> <xs:sequence> <xs:element name="Tipo"> <xs:annotation> <xs:documentation>Tipo de código de producto o servicio: 01: Código del producto del vendedor, 02 Código del producto del comprador, 03 Código del producto asignado por la industria, 04 Código de uso interno, 99 Otros</xs:documentation> </xs:annotation> <xs:simpleType> <xs:restriction base="xs:string"> <xs:enumeration value="01"> <xs:annotation> <xs:documentation>Código del producto del vendedor</xs:documentation> </xs:annotation> </xs:enumeration> <xs:enumeration value="02"> <xs:annotation> <xs:documentation>Código del producto del comprador</xs:documentation> </xs:annotation> </xs:enumeration> <xs:enumeration value="03"> <xs:annotation> <xs:documentation>código del producto asignado por la industria</xs:documentation> </xs:annotation> </xs:enumeration> <xs:enumeration value="04"> <xs:annotation> <xs:documentation>código de uso interno</xs:documentation> </xs:annotation> </xs:enumeration> <xs:enumeration value="99"> <xs:annotation> <xs:documentation>Otros</xs:documentation> </xs:annotation> </xs:enumeration> </xs:restriction> </xs:simpleType> </xs:element> </xs:sequence> </xs:complexType> </pre>

```

</xs:simpleType>
</xs:element>
<xs:element name="Codigo">
  <xs:annotation>
    <xs:documentation>Código del producto o servicio</xs:documentation>
  </xs:annotation>
  <xs:simpleType>
    <xs:restriction base="xs:string">
      <xs:maxLength value="20"/>
    </xs:restriction>
  </xs:simpleType>
</xs:element>
</xs:sequence>
</xs:complexType>

```

element **CodigoType/Tipo**

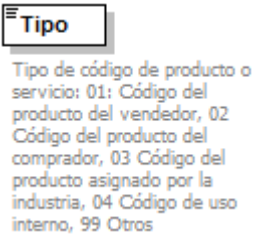
diagram	 <p>Tipo de código de producto o servicio: 01: Código del producto del vendedor, 02 Código del producto del comprador, 03 Código del producto asignado por la industria, 04 Código de uso interno, 99 Otros</p>																		
namespace	https://www.hacienda.go.cr/ATV/docs/esquemas/2016/v4/facturaElectronica																		
type	restriction of xs:string																		
properties	content simple																		
facets	<table border="1"> <thead> <tr> <th>Kind</th> <th>Value</th> <th>Annotation</th> </tr> </thead> <tbody> <tr> <td>enumeration</td> <td>01</td> <td>documentation Código del producto del vendedor</td> </tr> <tr> <td>enumeration</td> <td>02</td> <td>documentation Código del producto del comprador</td> </tr> <tr> <td>enumeration</td> <td>03</td> <td>documentation código del producto asignado por la industria</td> </tr> <tr> <td>enumeration</td> <td>04</td> <td>documentation código de uso interno</td> </tr> <tr> <td>enumeration</td> <td>99</td> <td>documentation Otros</td> </tr> </tbody> </table>	Kind	Value	Annotation	enumeration	01	documentation Código del producto del vendedor	enumeration	02	documentation Código del producto del comprador	enumeration	03	documentation código del producto asignado por la industria	enumeration	04	documentation código de uso interno	enumeration	99	documentation Otros
Kind	Value	Annotation																	
enumeration	01	documentation Código del producto del vendedor																	
enumeration	02	documentation Código del producto del comprador																	
enumeration	03	documentation código del producto asignado por la industria																	
enumeration	04	documentation código de uso interno																	
enumeration	99	documentation Otros																	
annotation	documentation Tipo de código de producto o servicio: 01: Código del producto del vendedor, 02 Código del producto del comprador, 03 Código del producto asignado por la industria, 04 Código de uso interno, 99 Otros																		
source	<pre> <xs:element name="Tipo"> <xs:annotation> <xs:documentation>Tipo de código de producto o servicio: 01: Código del producto del vendedor, 02 Código del producto del comprador, 03 Código del producto asignado por la industria, 04 Código de uso interno, 99 Otros</xs:documentation> </xs:annotation> <xs:simpleType> <xs:restriction base="xs:string"> <xs:enumeration value="01"> <xs:annotation> <xs:documentation>Código del producto del vendedor</xs:documentation> </xs:annotation> </xs:enumeration> </xs:restriction> </xs:simpleType> </xs:element> </pre>																		

	<pre> <xs:enumeration value="02"> <xs:annotation> <xs:documentation>Código del producto del comprador</xs:documentation> </xs:annotation> </xs:enumeration> <xs:enumeration value="03"> <xs:annotation> <xs:documentation>código del producto asignado por la industria</xs:documentation> </xs:annotation> </xs:enumeration> <xs:enumeration value="04"> <xs:annotation> <xs:documentation>código de uso interno</xs:documentation> </xs:annotation> </xs:enumeration> <xs:enumeration value="99"> <xs:annotation> <xs:documentation>Otros</xs:documentation> </xs:annotation> </xs:enumeration> </xs:restriction> </xs:simpleType> </xs:element> </pre>
--	-------------------------------------------------------------------------------------------------------------------------------------------------------------------------------------------------------------------------------------------------------------------------------------------------------------------------------------------------------------------------------------------------------------------------------------------------------------------------------------------------------------------------------------------------------------------------------------------------------------------------------------------------------------------------------------------------------------------------------------------------------------------------------------------------------------------------------------------------------------

element **CodigoType/Codigo**

diagram							
namespace	https://www.hacienda.go.cr/ATV/docs/esquemas/2016/v4/facturaElectronica						
type	restriction of xs:string						
properties	content simple						
facets	<table border="1"> <thead> <tr> <th>Kind</th> <th>Value</th> <th>Annotation</th> </tr> </thead> <tbody> <tr> <td>maxLength</td> <td>20</td> <td></td> </tr> </tbody> </table>	Kind	Value	Annotation	maxLength	20	
Kind	Value	Annotation					
maxLength	20						
annotation	documentation Código del producto o servicio						
source	<pre> <xs:element name="Codigo"> <xs:annotation> <xs:documentation>Código del producto o servicio</xs:documentation> </xs:annotation> <xs:simpleType> <xs:restriction base="xs:string"> <xs:maxLength value="20"/> </xs:restriction> </xs:simpleType> </xs:element> </pre>						

complexType EmisorType

<p>diagram</p>	<p>Nombre Nombre o razon social</p> <p>Identificacion +</p> <p>NombreComercial (dashed box) En caso de que se cuente con nombre comercial debe indicarse</p> <p>Ubicacion +</p> <p>Telefono + (dashed box)</p> <p>Fax + (dashed box)</p> <p>CorreoElectronico Debe cumplir con la siguiente estructura: $\backslash s^* \backslash w+([-.\s]^* \backslash w+)^* @ \backslash w+([-.\s]^* \backslash w+)^* \backslash s^*$</p>
<p>namespace</p>	<p>https://www.hacienda.go.cr/ATV/docs/esquemas/2016/v4/facturaElectronica</p>
<p>children</p>	<p>Nombre Identificacion NombreComercial Ubicacion Telefono Fax CorreoElectronico</p>
<p>used by</p>	<p>element FacturaElectronica/Emisor</p>
<p>source</p>	<pre><xs:complexType name="EmisorType"> <xs:sequence> <xs:element name="Nombre" nillable="false"> <xs:annotation> <xs:documentation>Nombre o razon social</xs:documentation> </xs:annotation> <xs:simpleType> <xs:restriction base="xs:string"> <xs:maxLength value="80"/> </xs:restriction> </xs:simpleType> </xs:element> <xs:element name="Identificacion" type="IdentificacionType"/> <xs:element name="NombreComercial" minOccurs="0"> <xs:annotation> <xs:documentation>En caso de que se cuente con nombre comercial debe indicarse</xs:documentation> </xs:annotation> <xs:simpleType> <xs:restriction base="xs:string"> <xs:maxLength value="80"/> </xs:restriction> </xs:simpleType> </xs:element> <xs:element name="Ubicacion" type="UbicacionType"/> <xs:element name="Telefono" type="TelefonoType" nillable="true" minOccurs="0"/> </xs:sequence> </xs:complexType></pre>

	<pre> <xs:element name="Fax" type="TelefonoType" nillable="true" minOccurs="0"/> <xs:element name="CorreoElectronico"> <xs:annotation> <xs:documentation>Debe cumplir con la siguiente estructura: \s*\w+([-+.]\w+)*@\w+([-.\w+)*\.\w+([-.\w+)*\s* </xs:documentation> </xs:annotation> <xs:simpleType> <xs:restriction base="xs:string"> <xs:pattern value="\s*\w+([-+.]\w+)*@\w+([-.\w+)*\.\w+([-.\w+)*\s*" /> </xs:restriction> </xs:simpleType> </xs:element> </xs:sequence> </xs:complexType> </pre>
--	-------------------------------------------------------------------------------------------------------------------------------------------------------------------------------------------------------------------------------------------------------------------------------------------------------------------------------------------------------------------------------------------------------------------------------------------------------------------------------------------------------------------------------------------------------------------------------------------------------------------------------

element EmisorType/Nombre

diagram							
namespace	https://www.hacienda.go.cr/ATV/docs/esquemas/2016/v4/facturaElectronica						
type	restriction of xs:string						
properties	content simple nillable false						
facets	<table border="1"> <thead> <tr> <th>Kind</th> <th>Value</th> <th>Annotation</th> </tr> </thead> <tbody> <tr> <td>maxLength</td> <td>80</td> <td></td> </tr> </tbody> </table>	Kind	Value	Annotation	maxLength	80	
Kind	Value	Annotation					
maxLength	80						
annotation	documentation Nombre o razon social						
source	<pre> <xs:element name="Nombre" nillable="false"> <xs:annotation> <xs:documentation>Nombre o razon social</xs:documentation> </xs:annotation> <xs:simpleType> <xs:restriction base="xs:string"> <xs:maxLength value="80"/> </xs:restriction> </xs:simpleType> </xs:element> </pre>						

element **EmisorType/Identificacion**

diagram	
namespace	https://www.hacienda.go.cr/ATV/docs/esquemas/2016/v4/facturaElectronica
type	IdentificacionType
properties	content complex
children	Tipo Numero
source	<code><xs:element name="Identificacion" type="IdentificacionType"/></code>

element **EmisorType/NombreComercial**

diagram	
namespace	https://www.hacienda.go.cr/ATV/docs/esquemas/2016/v4/facturaElectronica
type	restriction of xs:string
properties	minOcc 0 maxOcc 1 content simple
facets	Kind Value Annotation maxLength 80
annotation	documentation En caso de que se cuente con nombre comercial debe indicarse
source	<pre> <xs:element name="NombreComercial" minOccurs="0"> <xs:annotation> <xs:documentation>En caso de que se cuente con nombre comercial debe indicarse</xs:documentation> </xs:annotation> <xs:simpleType> <xs:restriction base="xs:string"> <xs:maxLength value="80"/> </xs:restriction> </xs:simpleType> </xs:element> </pre>

element EmisorType/Ubicacion

diagram	
namespace	https://www.hacienda.go.cr/ATV/docs/esquemas/2016/v4/facturaElectronica
type	UbicacionType
properties	content complex
children	Provincia Canton Distrito Barrio OtrasSenas
source	<code><xs:element name="Ubicacion" type="UbicacionType"/></code>

element EmisorType/Telefono

diagram	
namespace	https://www.hacienda.go.cr/ATV/docs/esquemas/2016/v4/facturaElectronica
type	TelefonoType
properties	minOcc 0 maxOcc 1 content complex nillable true
children	CodigoPais NumTelefono
source	<code><xs:element name="Telefono" type="TelefonoType" nillable="true" minOccurs="0"/></code>

element **EmisorType/Fax**

diagram	
namespace	https://www.hacienda.go.cr/ATV/docs/esquemas/2016/v4/facturaElectronica
type	TelefonoType
properties	minOcc 0 maxOcc 1 content complex nillable true
children	CodigoPais NumTelefono
source	<xs:element name="Fax" type="TelefonoType" nillable="true" minOccurs="0"/>

element **EmisorType/CorreoElectronico**

diagram	<div style="border: 1px solid black; padding: 5px; width: fit-content;"> CorreoElectronico </div> <p>Debe cumplir con la siguiente estructura:</p> <pre>\s*\w+([-.']\w+)*@\w+([-.]\w+)*\.\w+([-.]\w+)*\s*</pre>						
namespace	https://www.hacienda.go.cr/ATV/docs/esquemas/2016/v4/facturaElectronica						
type	restriction of xs:string						
properties	content simple						
facets	<table border="0"> <thead> <tr> <th>Kind</th> <th>Value</th> <th>Annotation</th> </tr> </thead> <tbody> <tr> <td>pattern</td> <td>\s*\w+([-.']\w+)*@\w+([-.]\w+)*\.\w+([-.]\w+)*\s*</td> <td></td> </tr> </tbody> </table>	Kind	Value	Annotation	pattern	\s*\w+([-.']\w+)*@\w+([-.]\w+)*\.\w+([-.]\w+)*\s*	
Kind	Value	Annotation					
pattern	\s*\w+([-.']\w+)*@\w+([-.]\w+)*\.\w+([-.]\w+)*\s*						
annotation	documentation Debe cumplir con la siguiente estructura: \s*\w+([-.']\w+)*@\w+([-.]\w+)*\.\w+([-.]\w+)*\s*						
source	<pre><xs:element name="CorreoElectronico"> <xs:annotation> <xs:documentation>Debe cumplir con la siguiente estructura: \s*\w+([-.']\w+)*@\w+([-.]\w+)*\.\w+([-.]\w+)*\s* </xs:documentation> </xs:annotation> <xs:simpleType> <xs:restriction base="xs:string"> <xs:pattern value="\s*\w+([-.']\w+)*@\w+([-.]\w+)*\.\w+([-.]\w+)*\s*" /> </xs:restriction> </xs:simpleType> </xs:element></pre>						

complexType ExoneracionType

<p>diagram</p>	<pre> classDiagram class ExoneracionType { TipoDocumento NumeroDocumento NombreInstitucion FechaEmision MontoImpuesto PorcentajeCompra } </pre> <p>TipoDocumento Tipo de documento de exoneración o autorización. 01 Compras Autorizadas, 02 Ventas exentas a diplomáticos, 03 Orden de compra (instituciones públicas y otros organismos), 04 Exenciones Dirección General de Hacienda, 05 Zonas Francas, 99 Otros</p> <p>NumeroDocumento Número de documento de exoneración o autorización</p> <p>NombreInstitucion Nombre de la institución o dependencia que emitió la exoneración</p> <p>FechaEmision Fecha y hora de la emisión del documento de exoneración o autorización.</p> <p>MontoImpuesto Monto del impuesto exonerado o autorizado sin impuestos</p> <p>PorcentajeCompra Porcentaje de la compra autorizada o exonerada</p>
<p>namespace</p>	<p>https://www.hacienda.go.cr/ATV/docs/esquemas/2016/v4/facturaElectronica</p>
<p>children</p>	<p>TipoDocumento NumeroDocumento NombreInstitucion FechaEmision MontoImpuesto PorcentajeCompra</p>
<p>used by</p>	<p>element FacturaElectronica/DetalleServicio/LineaDetalle/Exoneracion</p>
<p>source</p>	<pre> <xs:complexType name="ExoneracionType"> <xs:sequence> <xs:element name="TipoDocumento"> <xs:annotation> <xs:documentation>Tipo de documento de exoneración o autorización. 01 Compras Autorizadas, 02 Ventas exentas a diplomáticos, 03 Orden de compra (instituciones públicas y otros organismos), 04 Exenciones Dirección General de Hacienda, 05 Zonas Francas, 99 Otros</xs:documentation> </xs:annotation> <xs:simpleType> <xs:restriction base="xs:string"> <xs:enumeration value="01"> <xs:annotation> <xs:documentation>Compras Autorizadas</xs:documentation> </xs:annotation> </xs:enumeration> </xs:restriction> </xs:simpleType> </xs:element> </xs:sequence> </xs:complexType> </pre>

```

<xs:enumeration value="02">
  <xs:annotation>
    <xs:documentation>Ventas exentas a diplomáticos</xs:documentation>
  </xs:annotation>
</xs:enumeration>
<xs:enumeration value="03">
  <xs:annotation>
    <xs:documentation>Orden de compra (instituciones publicas y otros
organismos)</xs:documentation>
  </xs:annotation>
</xs:enumeration>
<xs:enumeration value="04">
  <xs:annotation>
    <xs:documentation>Exenciones Direccion General de Hacienda</xs:documentation>
  </xs:annotation>
</xs:enumeration>
<xs:enumeration value="05">
  <xs:annotation>
    <xs:documentation>Zonas Francas</xs:documentation>
  </xs:annotation>
</xs:enumeration>
<xs:enumeration value="99">
  <xs:annotation>
    <xs:documentation>Otros</xs:documentation>
  </xs:annotation>
</xs:enumeration>
</xs:restriction>
</xs:simpleType>
</xs:element>
<xs:element name="NumeroDocumento">
  <xs:annotation>
    <xs:documentation>Número de documento de exoneración o
autorización</xs:documentation>
  </xs:annotation>
  <xs:simpleType>
    <xs:restriction base="xs:string">
      <xs:maxLength value="17"/>
    </xs:restriction>
  </xs:simpleType>
</xs:element>
<xs:element name="NombreInstitucion">
  <xs:annotation>
    <xs:documentation>Nombre de la institución o dependencia que emitió la
exoneración</xs:documentation>
  </xs:annotation>
  <xs:simpleType>
    <xs:restriction base="xs:string">
      <xs:maxLength value="100"/>
    </xs:restriction>
  </xs:simpleType>
</xs:element>
<xs:element name="FechaEmision" type="xs:dateTime">
  <xs:annotation>
    <xs:documentation>Fecha y hora de la emisión del documento de exoneración o
autorización.</xs:documentation>
  </xs:annotation>

```

```

</xs:element>
<xs:element name="MontoImpuesto" type="DecimalDineroType">
  <xs:annotation>
    <xs:documentation>Monto del impuesto exonerado o autorizado sin
impuestos</xs:documentation>
  </xs:annotation>
</xs:element>
<xs:element name="PorcentajeCompra">
  <xs:annotation>
    <xs:documentation>Porcentaje de la compra autorizada o exonerada</xs:documentation>
  </xs:annotation>
  <xs:simpleType>
    <xs:restriction base="xs:integer">
      <xs:totalDigits value="3"/>
    </xs:restriction>
  </xs:simpleType>
</xs:element>
</xs:sequence>
</xs:complexType>

```

element **ExoneracionType/TipoDocumento**

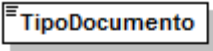
diagram	 <p>Tipo de documento de exoneración o autorización. 01 Compras Autorizadas, 02 Ventas exentas a diplomáticos, 03 Orden de compra (instituciones públicas y otros organismos), 04 Exenciones Dirección General de Hacienda, 05 Zonas Francas, 99 Otros</p>																					
namespace	https://www.hacienda.go.cr/ATV/docs/esquemas/2016/v4/facturaElectronica																					
type	restriction of xs:string																					
properties	content simple																					
facets	<table border="1"> <thead> <tr> <th>Kind</th> <th>Value</th> <th>Annotation</th> </tr> </thead> <tbody> <tr> <td>enumeration</td> <td>01</td> <td>documentation Compras Autorizadas</td> </tr> <tr> <td>enumeration</td> <td>02</td> <td>documentation Ventas exentas a diplomáticos</td> </tr> <tr> <td>enumeration</td> <td>03</td> <td>documentation Orden de compra (instituciones publicas y otros organismos)</td> </tr> <tr> <td>enumeration</td> <td>04</td> <td>documentation Exenciones Direccion General de Hacienda</td> </tr> <tr> <td>enumeration</td> <td>05</td> <td>documentation Zonas Francas</td> </tr> <tr> <td>enumeration</td> <td>99</td> <td>documentation Otros</td> </tr> </tbody> </table>	Kind	Value	Annotation	enumeration	01	documentation Compras Autorizadas	enumeration	02	documentation Ventas exentas a diplomáticos	enumeration	03	documentation Orden de compra (instituciones publicas y otros organismos)	enumeration	04	documentation Exenciones Direccion General de Hacienda	enumeration	05	documentation Zonas Francas	enumeration	99	documentation Otros
Kind	Value	Annotation																				
enumeration	01	documentation Compras Autorizadas																				
enumeration	02	documentation Ventas exentas a diplomáticos																				
enumeration	03	documentation Orden de compra (instituciones publicas y otros organismos)																				
enumeration	04	documentation Exenciones Direccion General de Hacienda																				
enumeration	05	documentation Zonas Francas																				
enumeration	99	documentation Otros																				
annotation	documentation Tipo de documento de exoneración o autorización. 01 Compras Autorizadas, 02 Ventas exentas a diplomáticos, 03 Orden de compra (instituciones públicas y otros organismos), 04 Exenciones Dirección General de Hacienda, 05 Zonas Francas, 99 Otros																					
source	<xs:element name="TipoDocumento"> <xs:annotation> <xs:documentation>Tipo de documento de exoneración o autorización. 01 Compras Autorizadas, 02 Ventas exentas a diplomáticos, 03 Orden de compra (instituciones públicas y otros																					

```

organismos), 04 Exenciones Dirección General de Hacienda, 05 Zonas Francas, 99
Otros</xs:documentation>
</xs:annotation>
<xs:simpleType>
  <xs:restriction base="xs:string">
    <xs:enumeration value="01">
      <xs:annotation>
        <xs:documentation>Compras Autorizadas</xs:documentation>
      </xs:annotation>
    </xs:enumeration>
    <xs:enumeration value="02">
      <xs:annotation>
        <xs:documentation>Ventas exentas a diplomáticos</xs:documentation>
      </xs:annotation>
    </xs:enumeration>
    <xs:enumeration value="03">
      <xs:annotation>
        <xs:documentation>Orden de compra (instituciones publicas y otros
organismos)</xs:documentation>
      </xs:annotation>
    </xs:enumeration>
    <xs:enumeration value="04">
      <xs:annotation>
        <xs:documentation>Exenciones Direccion General de Hacienda</xs:documentation>
      </xs:annotation>
    </xs:enumeration>
    <xs:enumeration value="05">
      <xs:annotation>
        <xs:documentation>Zonas Francas</xs:documentation>
      </xs:annotation>
    </xs:enumeration>
    <xs:enumeration value="99">
      <xs:annotation>
        <xs:documentation>Otros</xs:documentation>
      </xs:annotation>
    </xs:enumeration>
  </xs:restriction>
</xs:simpleType>
</xs:element>

```

element **ExoneracionType/NumeroDocumento**

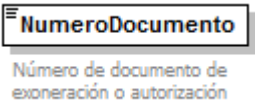
diagram							
namespace	https://www.hacienda.go.cr/ATV/docs/esquemas/2016/v4/facturaElectronica						
type	restriction of xs:string						
properties	content simple						
facets	<table border="0"> <tr> <td>Kind</td> <td>Value</td> <td>Annotation</td> </tr> <tr> <td>maxLength</td> <td>17</td> <td></td> </tr> </table>	Kind	Value	Annotation	maxLength	17	
Kind	Value	Annotation					
maxLength	17						
annotation	documentation Número de documento de exoneración o autorización						

source	<pre> <xs:element name="NumeroDocumento"> <xs:annotation> <xs:documentation>Número de documento de exoneración o autorización</xs:documentation> </xs:annotation> <xs:simpleType> <xs:restriction base="xs:string"> <xs:maxLength value="17"/> </xs:restriction> </xs:simpleType> </xs:element> </pre>
--------	----------------------------------------------------------------------------------------------------------------------------------------------------------------------------------------------------------------------------------------------------------------------------------------------------------------------------------------------------------------------------------------------------

element ExoneracionType/NombreInstitucion

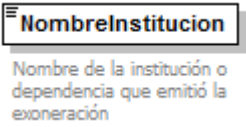
diagram							
namespace	https://www.hacienda.go.cr/ATV/docs/esquemas/2016/v4/facturaElectronica						
type	restriction of xs:string						
properties	content simple						
facets	<table border="1"> <thead> <tr> <th>Kind</th> <th>Value</th> <th>Annotation</th> </tr> </thead> <tbody> <tr> <td>maxLength</td> <td>100</td> <td></td> </tr> </tbody> </table>	Kind	Value	Annotation	maxLength	100	
Kind	Value	Annotation					
maxLength	100						
annotation	documentation Nombre de la institución o dependencia que emitió la exoneración						
source	<pre> <xs:element name="NombreInstitucion"> <xs:annotation> <xs:documentation>Nombre de la institución o dependencia que emitió la exoneración</xs:documentation> </xs:annotation> <xs:simpleType> <xs:restriction base="xs:string"> <xs:maxLength value="100"/> </xs:restriction> </xs:simpleType> </xs:element> </pre>						

element ExoneracionType/FechaEmision

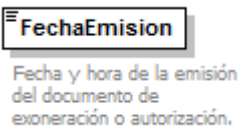
diagram	
namespace	https://www.hacienda.go.cr/ATV/docs/esquemas/2016/v4/facturaElectronica
type	xs:dateTime
properties	content simple
annotation	documentation Fecha y hora de la emisión del documento de exoneración o autorización.
source	<pre> <xs:element name="FechaEmision" type="xs:dateTime"> </pre>

	<pre> <xs:annotation> <xs:documentation>Fecha y hora de la emisión del documento de exoneración o autorización.</xs:documentation> </xs:annotation> </xs:element> </pre>
--	----------------------------------------------------------------------------------------------------------------------------------------------------------------------------------------------------------

element ExoneracionType/MontoImpuesto

diagram										
namespace	https://www.hacienda.go.cr/ATV/docs/esquemas/2016/v4/facturaElectronica									
type	DecimalDineroType									
properties	content simple									
facets	<table border="1"> <thead> <tr> <th>Kind</th> <th>Value</th> <th>Annotation</th> </tr> </thead> <tbody> <tr> <td>totalDigits</td> <td>18</td> <td></td> </tr> <tr> <td>fractionDigits</td> <td>5</td> <td></td> </tr> </tbody> </table>	Kind	Value	Annotation	totalDigits	18		fractionDigits	5	
Kind	Value	Annotation								
totalDigits	18									
fractionDigits	5									
annotation	documentation Monto del impuesto exonerado o autorizado sin impuestos									
source	<pre> <xs:element name="MontoImpuesto" type="DecimalDineroType"> <xs:annotation> <xs:documentation>Monto del impuesto exonerado o autorizado sin impuestos</xs:documentation> </xs:annotation> </xs:element> </pre>									

element ExoneracionType/PorcentajeCompra

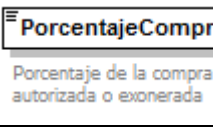
diagram							
namespace	https://www.hacienda.go.cr/ATV/docs/esquemas/2016/v4/facturaElectronica						
type	restriction of xs:integer						
properties	content simple						
facets	<table border="1"> <thead> <tr> <th>Kind</th> <th>Value</th> <th>Annotation</th> </tr> </thead> <tbody> <tr> <td>totalDigits</td> <td>3</td> <td></td> </tr> </tbody> </table>	Kind	Value	Annotation	totalDigits	3	
Kind	Value	Annotation					
totalDigits	3						
annotation	documentation Porcentaje de la compra autorizada o exonerada						
source	<pre> <xs:element name="PorcentajeCompra"> <xs:annotation> <xs:documentation>Porcentaje de la compra autorizada o exonerada</xs:documentation> </xs:annotation> <xs:simpleType> <xs:restriction base="xs:integer"> <xs:totalDigits value="3"/> </xs:restriction> </xs:simpleType> </pre>						

</xs:element>

complexType IdentificacionType

diagram

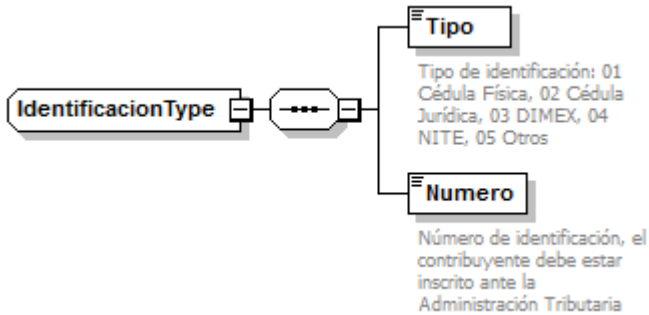

namespace <https://www.hacienda.go.cr/ATV/docs/esquemas/2016/v4/facturaElectronica>

children [Tipo](#) [Numero](#)

used by elements [EmisorType/Identificacion](#) [ReceptorType/Identificacion](#)

source

```
<xs:complexType name="IdentificacionType">
  <xs:sequence>
    <xs:element name="Tipo" nillable="false">
      <xs:annotation>
        <xs:documentation>Tipo de identificación: 01 Cédula Física, 02 Cédula Jurídica, 03 DIMEX, 04 NITE, 05 Otros</xs:documentation>
      </xs:annotation>
      <xs:simpleType>
        <xs:restriction base="xs:string">
          <xs:enumeration value="01">
            <xs:annotation>
              <xs:documentation>Cedula Fisica</xs:documentation>
            </xs:annotation>
          </xs:enumeration>
          <xs:enumeration value="02">
            <xs:annotation>
              <xs:documentation> Cedula Juridica</xs:documentation>
            </xs:annotation>
          </xs:enumeration>
          <xs:enumeration value="03">
            <xs:annotation>
              <xs:documentation>DIMEX</xs:documentation>
            </xs:annotation>
          </xs:enumeration>
          <xs:enumeration value="04">
            <xs:annotation>
              <xs:documentation>NITE</xs:documentation>
            </xs:annotation>
          </xs:enumeration>
          <xs:enumeration value="05">
            <xs:annotation>
              <xs:documentation>Otros</xs:documentation>
            </xs:annotation>
          </xs:enumeration>
        </xs:restriction>
      </xs:simpleType>
    </xs:element>
    <xs:element name="Numero">
      <xs:annotation>
        <xs:documentation>Número de identificación, el contribuyente debe estar inscrito ante la Administración Tributaria</xs:documentation>
      </xs:annotation>
      <xs:simpleType>
        <xs:restriction base="xs:string">
          <xs:enumeration value="01">
            <xs:annotation>
              <xs:documentation>Cedula Fisica</xs:documentation>
            </xs:annotation>
          </xs:enumeration>
          <xs:enumeration value="02">
            <xs:annotation>
              <xs:documentation> Cedula Juridica</xs:documentation>
            </xs:annotation>
          </xs:enumeration>
          <xs:enumeration value="03">
            <xs:annotation>
              <xs:documentation>DIMEX</xs:documentation>
            </xs:annotation>
          </xs:enumeration>
          <xs:enumeration value="04">
            <xs:annotation>
              <xs:documentation>NITE</xs:documentation>
            </xs:annotation>
          </xs:enumeration>
          <xs:enumeration value="05">
            <xs:annotation>
              <xs:documentation>Otros</xs:documentation>
            </xs:annotation>
          </xs:enumeration>
        </xs:restriction>
      </xs:simpleType>
    </xs:element>
  </xs:sequence>
</xs:complexType>
```

```

</xs:simpleType>
</xs:element>
<xs:element name="Numero" nillable="false">
  <xs:annotation>
    <xs:documentation>Número de identificación, el contribuyente debe estar inscrito ante la
Administración Tributaria</xs:documentation>
  </xs:annotation>
  <xs:simpleType>
    <xs:restriction base="xs:long">
      <xs:totalDigits value="12"/>
    </xs:restriction>
  </xs:simpleType>
</xs:element>
</xs:sequence>
</xs:complexType>

```

element IdentificacionTipo/Tipo

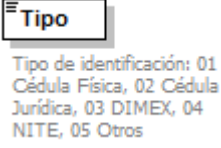
diagram																			
namespace	https://www.hacienda.go.cr/ATV/docs/esquemas/2016/v4/facturaElectronica																		
type	restriction of xs:string																		
properties	<table border="0"> <tr> <td>content</td> <td>simple</td> </tr> <tr> <td>nillable</td> <td>false</td> </tr> </table>	content	simple	nillable	false														
content	simple																		
nillable	false																		
facets	<table border="0"> <thead> <tr> <th>Kind</th> <th>Value</th> <th>Annotation</th> </tr> </thead> <tbody> <tr> <td>enumeration</td> <td>01</td> <td>documentation Cedula Fisica</td> </tr> <tr> <td>enumeration</td> <td>02</td> <td>documentation Cedula Juridica</td> </tr> <tr> <td>enumeration</td> <td>03</td> <td>documentation DIMEX</td> </tr> <tr> <td>enumeration</td> <td>04</td> <td>documentation NITE</td> </tr> <tr> <td>enumeration</td> <td>05</td> <td>documentation Otros</td> </tr> </tbody> </table>	Kind	Value	Annotation	enumeration	01	documentation Cedula Fisica	enumeration	02	documentation Cedula Juridica	enumeration	03	documentation DIMEX	enumeration	04	documentation NITE	enumeration	05	documentation Otros
Kind	Value	Annotation																	
enumeration	01	documentation Cedula Fisica																	
enumeration	02	documentation Cedula Juridica																	
enumeration	03	documentation DIMEX																	
enumeration	04	documentation NITE																	
enumeration	05	documentation Otros																	
annotation	documentation Tipo de identificación: 01 Cédula Física, 02 Cédula Jurídica, 03 DIMEX, 04 NITE, 05 Otros																		
source	<pre> <xs:element name="Tipo" nillable="false"> <xs:annotation> <xs:documentation>Tipo de identificación: 01 Cédula Física, 02 Cédula Jurídica, 03 DIMEX, 04 NITE, 05 Otros</xs:documentation> </xs:annotation> <xs:simpleType> <xs:restriction base="xs:string"> <xs:enumeration value="01"> <xs:annotation> <xs:documentation>Cedula Fisica</xs:documentation> </xs:annotation> </xs:enumeration> <xs:enumeration value="02"> <xs:annotation> <xs:documentation> Cedula Juridica</xs:documentation> </xs:annotation> </xs:enumeration> </xs:restriction> </xs:simpleType> </xs:element> </pre>																		

	<pre> </xs:enumeration> <xs:enumeration value="03"> <xs:annotation> <xs:documentation>DIMEX</xs:documentation> </xs:annotation> </xs:enumeration> <xs:enumeration value="04"> <xs:annotation> <xs:documentation>NITE</xs:documentation> </xs:annotation> </xs:enumeration> <xs:enumeration value="05"> <xs:annotation> <xs:documentation>Otros</xs:documentation> </xs:annotation> </xs:enumeration> </xs:restriction> </xs:simpleType> </xs:element> </pre>
--	--------------------------------------------------------------------------------------------------------------------------------------------------------------------------------------------------------------------------------------------------------------------------------------------------------------------------------------------------------------------------------------------------------------------------------------------------------------------------------------------------------------------------------------------------------------------------------------------------------------------------

element **IdentificacionType/Numero**

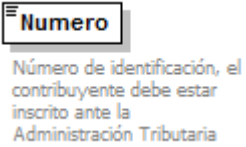
diagram	
namespace	https://www.hacienda.go.cr/ATV/docs/esquemas/2016/v4/facturaElectronica
type	restriction of xs:long
properties	content simple nillable false
facets	Kind Value Annotation totalDigits 12
annotation	documentation Número de identificación, el contribuyente debe estar inscrito ante la Administración Tributaria
source	<pre> <xs:element name="Numero" nillable="false"> <xs:annotation> <xs:documentation>Número de identificación, el contribuyente debe estar inscrito ante la Administración Tributaria</xs:documentation> </xs:annotation> <xs:simpleType> <xs:restriction base="xs:long"> <xs:totalDigits value="12"/> </xs:restriction> </xs:simpleType> </xs:element> </pre>

complexType ImpuestoType

<p>diagram</p>	<p>Codigo Código del impuesto: 01 Impuesto General sobre las ventas, 02 Impuesto Selectivo de Consumo, 03 Impuesto único a los combustivos, 04 Impuesto específico de bebidas alcohólicas, 05 Impuesto específico sobre las bebidas envasadas sin contenido alcohólico y jabones de tocador, 06 Impuesto a los productos de tabaco, 07 Servicios, 99 Otros, 08 Impuesto General a las Ventas Diplomáticos, 09 Impuesto General sobre Ventas compras autorizadas, 10 Impuesto General sobre las ventas instituciones públicas y otros organismos, 11 Impuesto Selectivo de consumo compras autorizadas</p> <p>Tarifa 1..∞ Tarifa del impuesto</p> <p>Monto Se obtiene de la multiplicación del campo subtotal por la tarifa del impuesto</p>
<p>namespace</p>	<p>https://www.hacienda.go.cr/ATV/docs/esquemas/2016/v4/facturaElectronica</p>
<p>children</p>	<p>Codigo Tarifa Monto</p>
<p>used by</p>	<p>elements FacturaElectronica/DetalleServicio/LineaDetalle/Impuesto FacturaElectronica/ResumenFactura/TotalImpuesto</p>
<p>source</p>	<pre><xs:complexType name="ImpuestoType"> <xs:sequence> <xs:element name="Codigo"> <xs:annotation> <xs:documentation>Código del impuesto: 01 Impuesto General sobre las ventas, 02 Impuesto Selectivo de Consumo, 03 Impuesto único a los combustivos, 04 Impuesto específico de bebidas alcohólicas, 05 Impuesto específico sobre las bebidas envasadas sin contenido alcohólico y jabones de tocador, 06 Impuesto a los productos de tabaco, 07 Servicios, 99 Otros, 08 Impuesto General a las Ventas Diplomáticos, 09 Impuesto General sobre Ventas compras autorizadas, 10 Impuesto General sobre las ventas instituciones públicas y otros organismos, 11 Impuesto Selectivo de consumo compras autorizadas</xs:documentation> </xs:annotation> <xs:simpleType> <xs:restriction base="xs:string"> <xs:enumeration value="01"> <xs:annotation> <xs:documentation>Impuesto General sobre las ventas</xs:documentation> </xs:annotation> </xs:enumeration> <xs:enumeration value="02"></pre>

```

<xs:annotation>
  <xs:documentation> Impuesto Selectivo de Consumo</xs:documentation>
</xs:annotation>
</xs:enumeration>
<xs:enumeration value="03">
  <xs:annotation>
    <xs:documentation>Impuesto único a los combustivos</xs:documentation>
  </xs:annotation>
</xs:enumeration>
<xs:enumeration value="04">
  <xs:annotation>
    <xs:documentation>Impuesto especifico de bebidas alcohólicas</xs:documentation>
  </xs:annotation>
</xs:enumeration>
<xs:enumeration value="05">
  <xs:annotation>
    <xs:documentation>impuesto especifico sobre las bebidas envasadas sin contenido
alcoholico y jabones de tocador</xs:documentation>
  </xs:annotation>
</xs:enumeration>
<xs:enumeration value="06">
  <xs:annotation>
    <xs:documentation>impuesto a los productos de tabaco</xs:documentation>
  </xs:annotation>
</xs:enumeration>
<xs:enumeration value="07">
  <xs:annotation>
    <xs:documentation>servicios</xs:documentation>
  </xs:annotation>
</xs:enumeration>
<xs:enumeration value="99">
  <xs:annotation>
    <xs:documentation>Otros</xs:documentation>
  </xs:annotation>
</xs:enumeration>
<xs:enumeration value="08">
  <xs:annotation>
    <xs:documentation>Impuesto General a las Ventas Diplomaticos</xs:documentation>
  </xs:annotation>
</xs:enumeration>
<xs:enumeration value="09">
  <xs:annotation>
    <xs:documentation>Impuesto General sobre Ventas compras
autorizadas</xs:documentation>
  </xs:annotation>
</xs:enumeration>
<xs:enumeration value="10">
  <xs:annotation>
    <xs:documentation>Impuesto General sobre las ventas instituciones publicas y otros
organismos</xs:documentation>
  </xs:annotation>
</xs:enumeration>
<xs:enumeration value="11">
  <xs:annotation>
    <xs:documentation>Impuesto Selectivo de consumo compras
autorizadas</xs:documentation>
  </xs:annotation>
</xs:enumeration>

```

	<pre> </xs:annotation> </xs:enumeration> </xs:restriction> </xs:simpleType> </xs:element> <xs:element name="Tarifa" maxOccurs="unbounded"> <xs:annotation> <xs:documentation>Tarifa del impuesto</xs:documentation> </xs:annotation> <xs:simpleType> <xs:restriction base="xs:decimal"> <xs:totalDigits value="4"/> <xs:fractionDigits value="2"/> </xs:restriction> </xs:simpleType> </xs:element> <xs:element name="Monto" type="DecimalDineroType"> <xs:annotation> <xs:documentation>Se obtiene de la multiplicación del campo subtotal por la tarifa del impuesto</xs:documentation> </xs:annotation> </xs:element> </xs:sequence> </xs:complexType> </pre>
--	----------------------------------------------------------------------------------------------------------------------------------------------------------------------------------------------------------------------------------------------------------------------------------------------------------------------------------------------------------------------------------------------------------------------------------------------------------------------------------------------------------------------------------------------------------------------------------------------------------------------------------------------------------------------------------------------------------------------------------------------------------------------------------------------------------------------------------------------------------------

element ImpuestoType/Codigo

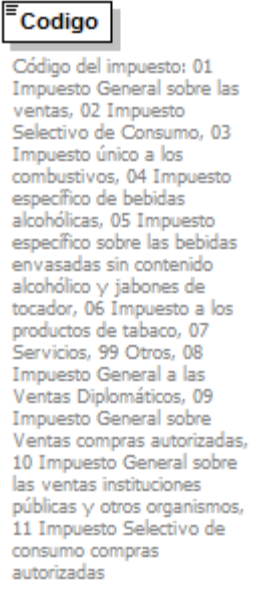
diagram	 <p>Codigo</p> <p>Código del impuesto: 01 Impuesto General sobre las ventas, 02 Impuesto Selectivo de Consumo, 03 Impuesto único a los combustivos, 04 Impuesto específico de bebidas alcohólicas, 05 Impuesto específico sobre las bebidas envasadas sin contenido alcohólico y jabones de tocador, 06 Impuesto a los productos de tabaco, 07 Servicios, 99 Otros, 08 Impuesto General a las Ventas Diplomáticos, 09 Impuesto General sobre Ventas compras autorizadas, 10 Impuesto General sobre las ventas instituciones públicas y otros organismos, 11 Impuesto Selectivo de consumo compras autorizadas</p>									
namespace	https://www.hacienda.go.cr/ATV/docs/esquemas/2016/v4/facturaElectronica									
type	restriction of xs:string									
properties	content simple									
facets	<table border="1"> <thead> <tr> <th>Kind</th> <th>Value</th> <th>Annotation</th> </tr> </thead> <tbody> <tr> <td>enumeration</td> <td>01</td> <td>documentation Impuesto General sobre las ventas</td> </tr> <tr> <td>enumeration</td> <td>02</td> <td>documentation</td> </tr> </tbody> </table>	Kind	Value	Annotation	enumeration	01	documentation Impuesto General sobre las ventas	enumeration	02	documentation
Kind	Value	Annotation								
enumeration	01	documentation Impuesto General sobre las ventas								
enumeration	02	documentation								

	<p>enumeration 03</p> <p>enumeration 04</p> <p>enumeration 05</p> <p>enumeration 06</p> <p>enumeration 07</p> <p>enumeration 99</p> <p>enumeration 08</p> <p>enumeration 09</p> <p>enumeration 10</p> <p>enumeration 11</p>	<p>Impuesto Selectivo de Consumo documentation</p> <p>Impuesto único a los combustivos documentation</p> <p>Impuesto específico de bebidas alcohólicas documentation</p> <p>impuesto específico sobre las bebidas envasadas sin contenido alcoholico y jabones de tocador documentation</p> <p>impuesto a los productos de tabaco documentation</p> <p>servicios documentation</p> <p>Otros documentation</p> <p>Impuesto General a las Ventas Diplomaticos documentation</p> <p>Impuesto General sobre Ventas compras autorizadas documentation</p> <p>Impuesto General sobre las ventas instituciones publicas y otros organismos documentation</p> <p>Impuesto Selectivo de consumo compras autorizadas</p>
<p>annotation</p>	<p>documentation</p>	<p>Código del impuesto: 01 Impuesto General sobre las ventas, 02 Impuesto Selectivo de Consumo, 03 Impuesto único a los combustivos, 04 Impuesto específico de bebidas alcohólicas, 05 Impuesto específico sobre las bebidas envasadas sin contenido alcohólico y jabones de tocador, 06 Impuesto a los productos de tabaco, 07 Servicios, 99 Otros, 08 Impuesto General a las Ventas Diplomáticos, 09 Impuesto General sobre Ventas compras autorizadas, 10 Impuesto General sobre las ventas instituciones públicas y otros organismos, 11 Impuesto Selectivo de consumo compras autorizadas</p>
<p>source</p>		<pre> <xs:element name="Codigo"> <xs:annotation> <xs:documentation>Código del impuesto: 01 Impuesto General sobre las ventas, 02 Impuesto Selectivo de Consumo, 03 Impuesto único a los combustivos, 04 Impuesto específico de bebidas alcohólicas, 05 Impuesto específico sobre las bebidas envasadas sin contenido alcohólico y jabones de tocador, 06 Impuesto a los productos de tabaco, 07 Servicios, 99 Otros, 08 Impuesto General a las Ventas Diplomáticos, 09 Impuesto General sobre Ventas compras autorizadas, 10 Impuesto General sobre las ventas instituciones públicas y otros organismos, 11 Impuesto Selectivo de consumo compras autorizadas</xs:documentation> </xs:annotation> <xs:simpleType> <xs:restriction base="xs:string"> <xs:enumeration value="01"> <xs:annotation> <xs:documentation>Impuesto General sobre las ventas</xs:documentation> </xs:annotation> </xs:enumeration> <xs:enumeration value="02"> <xs:annotation> <xs:documentation> Impuesto Selectivo de Consumo</xs:documentation> </xs:annotation> </xs:enumeration> <xs:enumeration value="03"> <xs:annotation> <xs:documentation>Impuesto único a los combustivos</xs:documentation> </xs:annotation> </xs:enumeration> <xs:enumeration value="04"> <xs:annotation> <xs:documentation>Impuesto específico de bebidas alcohólicas</xs:documentation> </xs:annotation> </xs:enumeration> </xs:restriction> </xs:simpleType> </xs:element> </pre>

```

<xs:enumeration value="05">
  <xs:annotation>
    <xs:documentation>impuesto especifico sobre las bebidas envasadas sin contenido
alcoholico y jabones de tocador</xs:documentation>
  </xs:annotation>
</xs:enumeration>
<xs:enumeration value="06">
  <xs:annotation>
    <xs:documentation>impuesto a los productos de tabaco</xs:documentation>
  </xs:annotation>
</xs:enumeration>
<xs:enumeration value="07">
  <xs:annotation>
    <xs:documentation>servicios</xs:documentation>
  </xs:annotation>
</xs:enumeration>
<xs:enumeration value="99">
  <xs:annotation>
    <xs:documentation>Otros</xs:documentation>
  </xs:annotation>
</xs:enumeration>
<xs:enumeration value="08">
  <xs:annotation>
    <xs:documentation>Impuesto General a las Ventas Diplomaticos</xs:documentation>
  </xs:annotation>
</xs:enumeration>
<xs:enumeration value="09">
  <xs:annotation>
    <xs:documentation>Impuesto General sobre Ventas compras
autorizadas</xs:documentation>
  </xs:annotation>
</xs:enumeration>
<xs:enumeration value="10">
  <xs:annotation>
    <xs:documentation>Impuesto General sobre las ventas instituciones publicas y otros
organismos</xs:documentation>
  </xs:annotation>
</xs:enumeration>
<xs:enumeration value="11">
  <xs:annotation>
    <xs:documentation>Impuesto Selectivo de consumo compras
autorizadas</xs:documentation>
  </xs:annotation>
</xs:enumeration>
</xs:restriction>
</xs:simpleType>
</xs:element>

```

element **ImpuestoType/Tarifa**

diagram



1..∞

Tarifa del impuesto

namespace	https://www.hacienda.go.cr/ATV/docs/esquemas/2016/v4/facturaElectronica									
type	restriction of xs:decimal									
properties	minOcc 1 maxOcc unbounded content simple									
facets	<table border="1"> <thead> <tr> <th>Kind</th> <th>Value</th> <th>Annotation</th> </tr> </thead> <tbody> <tr> <td>totalDigits</td> <td>4</td> <td></td> </tr> <tr> <td>fractionDigits</td> <td>2</td> <td></td> </tr> </tbody> </table>	Kind	Value	Annotation	totalDigits	4		fractionDigits	2	
Kind	Value	Annotation								
totalDigits	4									
fractionDigits	2									
annotation	documentation Tarifa del impuesto									
source	<pre><xs:element name="Tarifa" maxOccurs="unbounded"> <xs:annotation> <xs:documentation>Tarifa del impuesto</xs:documentation> </xs:annotation> <xs:simpleType> <xs:restriction base="xs:decimal"> <xs:totalDigits value="4"/> <xs:fractionDigits value="2"/> </xs:restriction> </xs:simpleType> </xs:element></pre>									

element ImpuestoType/Monto

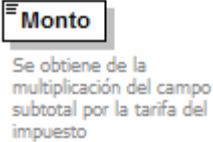
diagram										
namespace	https://www.hacienda.go.cr/ATV/docs/esquemas/2016/v4/facturaElectronica									
type	DecimalDineroType									
properties	content simple									
facets	<table border="1"> <thead> <tr> <th>Kind</th> <th>Value</th> <th>Annotation</th> </tr> </thead> <tbody> <tr> <td>totalDigits</td> <td>18</td> <td></td> </tr> <tr> <td>fractionDigits</td> <td>5</td> <td></td> </tr> </tbody> </table>	Kind	Value	Annotation	totalDigits	18		fractionDigits	5	
Kind	Value	Annotation								
totalDigits	18									
fractionDigits	5									
annotation	documentation Se obtiene de la multiplicación del campo subtotal por la tarifa del impuesto									
source	<pre><xs:element name="Monto" type="DecimalDineroType"> <xs:annotation> <xs:documentation>Se obtiene de la multiplicación del campo subtotal por la tarifa del impuesto</xs:documentation> </xs:annotation> </xs:element></pre>									

complexType ReceptorType

<p>diagram</p>	
<p>namespace</p>	<p>https://www.hacienda.go.cr/ATV/docs/esquemas/2016/v4/facturaElectronica</p>
<p>children</p>	<p>Nombre Identificacion IdentificacionExtranjero NombreComercial Ubicacion Telefono Fax CorreoElectronico</p>
<p>used by</p>	<p>element FacturaElectronica/Receptor</p>
<p>source</p>	<pre><xs:complexType name="ReceptorType"> <xs:sequence> <xs:element name="Nombre" nillable="false"> <xs:annotation> <xs:documentation>Nombre o razon social</xs:documentation> </xs:annotation> <xs:simpleType> <xs:restriction base="xs:string"> <xs:maxLength value="80"/> </xs:restriction> </xs:simpleType> </xs:element> <xs:element name="Identificacion" type="IdentificacionType" minOccurs="0"/> <xs:element name="IdentificacionExtranjero" minOccurs="0"> <xs:annotation> <xs:documentation>Este campo será de condición obligatoria, cuando el cliente lo requiera</xs:documentation> </xs:annotation> <xs:simpleType> </pre>

```

<xs:restriction base="xs:string">
  <xs:maxLength value="20"/>
</xs:restriction>
</xs:simpleType>
</xs:element>
<xs:element name="NombreComercial" minOccurs="0">
  <xs:annotation>
    <xs:documentation>En caso de que se cuente con nombre comercial debe
indicarse</xs:documentation>
  </xs:annotation>
  <xs:simpleType>
    <xs:restriction base="xs:string">
      <xs:maxLength value="80"/>
    </xs:restriction>
  </xs:simpleType>
</xs:element>
<xs:element name="Ubicacion" type="UbicacionType" minOccurs="0"/>
<xs:element name="Telefono" type="TelefonoType" minOccurs="0"/>
<xs:element name="Fax" type="TelefonoType" minOccurs="0"/>
<xs:element name="CorreoElectronico" minOccurs="0">
  <xs:annotation>
    <xs:documentation>Este campo será de condición obligatoria, cuando el cliente lo requiera.
Debe cumplir con la siguiente estructura:
\s*\w+([-+.']\w+)*@\w+([-.\w+)*\.\w+([-.\w+)*\s*
</xs:documentation>
  </xs:annotation>
  <xs:simpleType>
    <xs:restriction base="xs:string">
      <xs:pattern value="\s*\w+([-+.']\w+)*@\w+([-.\w+)*\.\w+([-.\w+)*\s*" />
    </xs:restriction>
  </xs:simpleType>
</xs:element>
</xs:sequence>
</xs:complexType>

```

element **ReceptorType/Nombre**

diagram	
namespace	https://www.hacienda.go.cr/ATV/docs/esquemas/2016/v4/facturaElectronica
type	restriction of xs:string
properties	content simple nillable false
facets	Kind Value Annotation maxLength 80
annotation	documentation Nombre o razon social
source	<pre> <xs:element name="Nombre" nillable="false"> <xs:annotation> <xs:documentation>Nombre o razon social</xs:documentation> </xs:annotation> <xs:simpleType> </pre>

	<pre> <xs:restriction base="xs:string"> <xs:maxLength value="80"/> </xs:restriction> </xs:simpleType> </xs:element> </pre>
--	------------------------------------------------------------------------------------------------------------------------------------------------------------

element ReceptorType/Identificacion

diagram	
namespace	https://www.hacienda.go.cr/ATV/docs/esquemas/2016/v4/facturaElectronica
type	IdentificacionType
properties	minOcc 0 maxOcc 1 content complex
children	Tipo Numero
source	<pre><xs:element name="Identificacion" type="IdentificacionType" minOccurs="0"/></pre>

element ReceptorType/IdentificacionExtranjero

diagram	
namespace	https://www.hacienda.go.cr/ATV/docs/esquemas/2016/v4/facturaElectronica
type	restriction of xs:string
properties	minOcc 0 maxOcc 1 content simple
facets	Kind Value Annotation maxLength 20
annotation	documentation Este campo será de condición obligatoria, cuando el cliente lo requiera
source	<pre> <xs:element name="IdentificacionExtranjero" minOccurs="0"> <xs:annotation> <xs:documentation>Este campo será de condición obligatoria, cuando el cliente lo requiera</xs:documentation> </xs:annotation> </xs:simpleType> </pre>

	<pre> <xs:restriction base="xs:string"> <xs:maxLength value="20"/> </xs:restriction> </xs:simpleType> </xs:element> </pre>
--	------------------------------------------------------------------------------------------------------------------------------------------------------------

element ReceptorType/NombreComercial

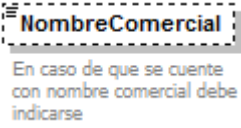
diagram							
namespace	https://www.hacienda.go.cr/ATV/docs/esquemas/2016/v4/facturaElectronica						
type	restriction of xs:string						
properties	minOcc 0 maxOcc 1 content simple						
facets	<table border="0"> <tr> <td>Kind</td> <td>Value</td> <td>Annotation</td> </tr> <tr> <td>maxLength</td> <td>80</td> <td></td> </tr> </table>	Kind	Value	Annotation	maxLength	80	
Kind	Value	Annotation					
maxLength	80						
annotation	documentation En caso de que se cuente con nombre comercial debe indicarse						
source	<pre> <xs:element name="NombreComercial" minOccurs="0"> <xs:annotation> <xs:documentation>En caso de que se cuente con nombre comercial debe indicarse</xs:documentation> </xs:annotation> <xs:simpleType> <xs:restriction base="xs:string"> <xs:maxLength value="80"/> </xs:restriction> </xs:simpleType> </xs:element> </pre>						

element ReceptorType/Ubicacion

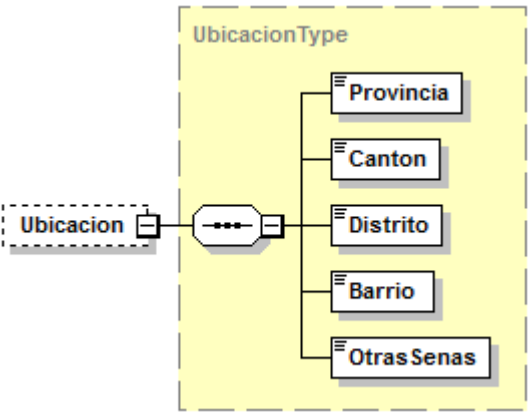
diagram	
namespace	https://www.hacienda.go.cr/ATV/docs/esquemas/2016/v4/facturaElectronica
type	UbicacionType

properties	minOcc 0 maxOcc 1 content complex
children	Provincia Canton Distrito Barrio OtrasSenas
source	<code><xs:element name="Ubicacion" type="UbicacionType" minOccurs="0"/></code>

element ReceptorType/Telefono

diagram	
namespace	https://www.hacienda.go.cr/ATV/docs/esquemas/2016/v4/facturaElectronica
type	TelefonoType
properties	minOcc 0 maxOcc 1 content complex
children	CodigoPais NumTelefono
source	<code><xs:element name="Telefono" type="TelefonoType" minOccurs="0"/></code>

element ReceptorType/Fax

diagram	
namespace	https://www.hacienda.go.cr/ATV/docs/esquemas/2016/v4/facturaElectronica
type	TelefonoType
properties	minOcc 0 maxOcc 1 content complex
children	CodigoPais NumTelefono
source	<code><xs:element name="Fax" type="TelefonoType" minOccurs="0"/></code>

element ReceptorType/CorreoElectronico

diagram	 <p>Este campo será de condición obligatoria, cuando el cliente lo requiera. Debe cumplir con la siguiente estructura:</p> <pre>\s*\w+([-.']\w+)*@\w+([-.']\w+)*\.\w+([-.']\w+)*\s*</pre>
namespace	https://www.hacienda.go.cr/ATV/docs/esquemas/2016/v4/facturaElectronica
type	restriction of xs:string
properties	minOcc 0 maxOcc 1 content simple
facets	Kind Value Annotation pattern \s*\w+([-.']\w+)*@\w+([-.']\w+)*\.\w+([-.']\w+)*\s*
annotation	documentation Este campo será de condición obligatoria, cuando el cliente lo requiera. Debe cumplir con la siguiente estructura: \s*\w+([-.']\w+)*@\w+([-.']\w+)*\.\w+([-.']\w+)*\s*
source	<pre><xs:element name="CorreoElectronico" minOccurs="0"> <xs:annotation> <xs:documentation>Este campo será de condición obligatoria, cuando el cliente lo requiera. Debe cumplir con la siguiente estructura: \s*\w+([-.']\w+)*@\w+([-.']\w+)*\.\w+([-.']\w+)*\s* </xs:documentation> </xs:annotation> <xs:simpleType> <xs:restriction base="xs:string"> <xs:pattern value="\s*\w+([-.']\w+)*@\w+([-.']\w+)*\.\w+([-.']\w+)*\s*" /> </xs:restriction> </xs:simpleType> </xs:element></pre>

complexType TelefonoType

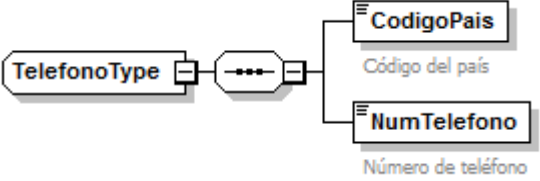
diagram	 <p>The diagram shows a sequence container for the TelefonoType complex type. It contains two child elements: 'CodigoPais' (labeled 'Código del país') and 'NumTelefono' (labeled 'Número de teléfono').</p>
namespace	https://www.hacienda.go.cr/ATV/docs/esquemas/2016/v4/facturaElectronica
children	CodigoPais NumTelefono
used by	elements EmisorType/Fax ReceptorType/Fax EmisorType/Telefono ReceptorType/Telefono
source	<pre><xs:complexType name="TelefonoType"> <xs:sequence> <xs:element name="CodigoPais"> <xs:annotation> <xs:documentation>Código del país</xs:documentation></pre>

	<pre> </xs:annotation> <xs:simpleType> <xs:restriction base="xs:integer"> <xs:totalDigits value="3"/> </xs:restriction> </xs:simpleType> </xs:element> <xs:element name="NumTelefono"> <xs:annotation> <xs:documentation>Número de teléfono</xs:documentation> </xs:annotation> <xs:simpleType> <xs:restriction base="xs:integer"> <xs:totalDigits value="20"/> </xs:restriction> </xs:simpleType> </xs:element> </xs:sequence> </xs:complexType> </pre>
--	--------------------------------------------------------------------------------------------------------------------------------------------------------------------------------------------------------------------------------------------------------------------------------------------------------------------------------------------------------------------------------------------------------------------------------------------------------------------------------------------------------------------------------------------------------------------------------------------------------------------

element TelefonoType/CodigoPais

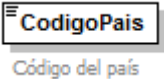
diagram							
namespace	https://www.hacienda.go.cr/ATV/docs/esquemas/2016/v4/facturaElectronica						
type	restriction of xs:integer						
properties	content simple						
facets	<table border="1"> <thead> <tr> <th>Kind</th> <th>Value</th> <th>Annotation</th> </tr> </thead> <tbody> <tr> <td>totalDigits</td> <td>3</td> <td></td> </tr> </tbody> </table>	Kind	Value	Annotation	totalDigits	3	
Kind	Value	Annotation					
totalDigits	3						
annotation	documentation Código del país						
source	<pre> <xs:element name="CodigoPais"> <xs:annotation> <xs:documentation>Código del país</xs:documentation> </xs:annotation> <xs:simpleType> <xs:restriction base="xs:integer"> <xs:totalDigits value="3"/> </xs:restriction> </xs:simpleType> </xs:element> </pre>						

element TelefonoType/NumTelefono

diagram	
namespace	https://www.hacienda.go.cr/ATV/docs/esquemas/2016/v4/facturaElectronica
type	restriction of xs:integer

properties	content simple
facets	Kind Value Annotation totalDigits 20
annotation	documentation Número de teléfono
source	<pre> <xs:element name="NumTelefono"> <xs:annotation> <xs:documentation>Número de teléfono</xs:documentation> </xs:annotation> <xs:simpleType> <xs:restriction base="xs:integer"> <xs:totalDigits value="20"/> </xs:restriction> </xs:simpleType> </xs:element> </pre>

complexType UbicacionType

diagram	
namespace	https://www.hacienda.go.cr/ATV/docs/esquemas/2016/v4/facturaElectronica
children	Provincia Canton Distrito Barrio OtrasSenas
used by	elements EmisorType/Ubicacion ReceptorType/Ubicacion
source	<pre> <xs:complexType name="UbicacionType"> <xs:sequence> <xs:element name="Provincia"> <xs:simpleType> <xs:restriction base="xs:string"> <xs:minLength value="1"/> <xs:maxLength value="1"/> <xs:pattern value="\d"/> </xs:restriction> </xs:simpleType> </xs:element> <xs:element name="Canton"> <xs:simpleType> <xs:restriction base="xs:string"> <xs:minLength value="2"/> <xs:maxLength value="2"/> <xs:pattern value="\d\d"/> </xs:restriction> </xs:simpleType> </xs:element> <xs:element name="Distrito"> <xs:simpleType> <xs:restriction base="xs:string"> <xs:minLength value="3"/> <xs:maxLength value="3"/> <xs:pattern value="\d\d\d"/> </xs:restriction> </xs:simpleType> </xs:element> <xs:element name="Barrio"> <xs:simpleType> <xs:restriction base="xs:string"> <xs:minLength value="4"/> <xs:maxLength value="4"/> <xs:pattern value="\d\d\d\d"/> </xs:restriction> </xs:simpleType> </xs:element> <xs:element name="Otras Senas"> <xs:simpleType> <xs:restriction base="xs:string"> <xs:minLength value="1"/> <xs:maxLength value="1"/> <xs:pattern value="."/> </xs:restriction> </xs:simpleType> </xs:element> </xs:sequence> </xs:complexType> </pre>

```

<xs:element name="Distrito">
  <xs:simpleType>
    <xs:restriction base="xs:string">
      <xs:pattern value="\d\d"/>
    </xs:restriction>
  </xs:simpleType>
</xs:element>
<xs:element name="Barrio">
  <xs:simpleType>
    <xs:restriction base="xs:string">
      <xs:pattern value="\d\d"/>
    </xs:restriction>
  </xs:simpleType>
</xs:element>
<xs:element name="OtrasSenas">
  <xs:simpleType>
    <xs:restriction base="xs:string">
      <xs:maxLength value="160"/>
    </xs:restriction>
  </xs:simpleType>
</xs:element>
</xs:sequence>
</xs:complexType>

```

element **UbicacionType/Provincia**

diagram													
namespace	https://www.hacienda.go.cr/ATV/docs/esquemas/2016/v4/facturaElectronica												
type	restriction of xs:string												
properties	content simple												
facets	<table border="1"> <thead> <tr> <th>Kind</th> <th>Value</th> <th>Annotation</th> </tr> </thead> <tbody> <tr> <td>minLength</td> <td>1</td> <td></td> </tr> <tr> <td>maxLength</td> <td>1</td> <td></td> </tr> <tr> <td>pattern</td> <td>\d</td> <td></td> </tr> </tbody> </table>	Kind	Value	Annotation	minLength	1		maxLength	1		pattern	\d	
Kind	Value	Annotation											
minLength	1												
maxLength	1												
pattern	\d												
source	<pre> <xs:element name="Provincia"> <xs:simpleType> <xs:restriction base="xs:string"> <xs:minLength value="1"/> <xs:maxLength value="1"/> <xs:pattern value="\d"/> </xs:restriction> </xs:simpleType> </xs:element> </pre>												

element **UbicacionType/Canton**

diagram	
---------	--

namespace	https://www.hacienda.go.cr/ATV/docs/esquemas/2016/v4/facturaElectronica												
type	restriction of xs:string												
properties	content simple												
facets	<table border="1"> <thead> <tr> <th>Kind</th> <th>Value</th> <th>Annotation</th> </tr> </thead> <tbody> <tr> <td>minLength</td> <td>2</td> <td></td> </tr> <tr> <td>maxLength</td> <td>2</td> <td></td> </tr> <tr> <td>pattern</td> <td>\d\d</td> <td></td> </tr> </tbody> </table>	Kind	Value	Annotation	minLength	2		maxLength	2		pattern	\d\d	
Kind	Value	Annotation											
minLength	2												
maxLength	2												
pattern	\d\d												
source	<pre> <xs:element name="Canton"> <xs:simpleType> <xs:restriction base="xs:string"> <xs:minLength value="2"/> <xs:maxLength value="2"/> <xs:pattern value="\d\d"/> </xs:restriction> </xs:simpleType> </xs:element> </pre>												

element **UbicacionType/Distrito**

diagram							
namespace	https://www.hacienda.go.cr/ATV/docs/esquemas/2016/v4/facturaElectronica						
type	restriction of xs:string						
properties	content simple						
facets	<table border="1"> <thead> <tr> <th>Kind</th> <th>Value</th> <th>Annotation</th> </tr> </thead> <tbody> <tr> <td>pattern</td> <td>\d\d</td> <td></td> </tr> </tbody> </table>	Kind	Value	Annotation	pattern	\d\d	
Kind	Value	Annotation					
pattern	\d\d						
source	<pre> <xs:element name="Distrito"> <xs:simpleType> <xs:restriction base="xs:string"> <xs:pattern value="\d\d"/> </xs:restriction> </xs:simpleType> </xs:element> </pre>						

element **UbicacionType/Barrio**

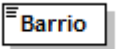
diagram							
namespace	https://www.hacienda.go.cr/ATV/docs/esquemas/2016/v4/facturaElectronica						
type	restriction of xs:string						
properties	content simple						
facets	<table border="1"> <thead> <tr> <th>Kind</th> <th>Value</th> <th>Annotation</th> </tr> </thead> <tbody> <tr> <td>pattern</td> <td>\d\d</td> <td></td> </tr> </tbody> </table>	Kind	Value	Annotation	pattern	\d\d	
Kind	Value	Annotation					
pattern	\d\d						
source	<pre> <xs:element name="Barrio"> <xs:simpleType> <xs:restriction base="xs:string"> </pre>						

	<pre> <xs:pattern value="\d\d"/> </xs:restriction> </xs:simpleType> </xs:element> </pre>
--	------------------------------------------------------------------------------------------------------------------

element UbicacionType/OtrasSenas

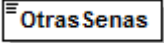
diagram							
namespace	https://www.hacienda.go.cr/ATV/docs/esquemas/2016/v4/facturaElectronica						
type	restriction of xs:string						
properties	content simple						
facets	<table border="1"> <thead> <tr> <th>Kind</th> <th>Value</th> <th>Annotation</th> </tr> </thead> <tbody> <tr> <td>maxLength</td> <td>160</td> <td></td> </tr> </tbody> </table>	Kind	Value	Annotation	maxLength	160	
Kind	Value	Annotation					
maxLength	160						
source	<pre> <xs:element name="OtrasSenas"> <xs:simpleType> <xs:restriction base="xs:string"> <xs:maxLength value="160"/> </xs:restriction> </xs:simpleType> </xs:element> </pre>						

simpleType ClaveType

namespace	https://www.hacienda.go.cr/ATV/docs/esquemas/2016/v4/facturaElectronica						
type	restriction of xs:string						
properties	base xs:string						
used by	element FacturaElectronica/Clave						
facets	<table border="1"> <thead> <tr> <th>Kind</th> <th>Value</th> <th>Annotation</th> </tr> </thead> <tbody> <tr> <td>pattern</td> <td>\d{50,50}</td> <td></td> </tr> </tbody> </table>	Kind	Value	Annotation	pattern	\d{50,50}	
Kind	Value	Annotation					
pattern	\d{50,50}						
annotation	documentation Tipo de dato String que solo permite el uso de números con un largo de 50.						
source	<pre> <xs:simpleType name="ClaveType"> <xs:annotation> <xs:documentation>Tipo de dato String que solo permite el uso de números con un largo de 50.</xs:documentation> </xs:annotation> <xs:restriction base="xs:string"> <xs:pattern value="\d{50,50}"/> </xs:restriction> </xs:simpleType> </pre>						

simpleType DecimalDineroType

namespace	https://www.hacienda.go.cr/ATV/docs/esquemas/2016/v4/facturaElectronica
type	restriction of xs:decimal
properties	base xs:decimal

used by	elements	ImpuestoType/Monto FacturaElectronica/DetalleServicio/LineaDetalle/MontoDescuento ExoneracionType/MontoImpuesto FacturaElectronica/DetalleServicio/LineaDetalle/MontoTotal FacturaElectronica/DetalleServicio/LineaDetalle/MontoTotalLinea FacturaElectronica/DetalleServicio/LineaDetalle/PrecioUnitario FacturaElectronica/DetalleServicio/LineaDetalle/SubTotal FacturaElectronica/ResumenFactura/TipoCambio FacturaElectronica/ResumenFactura/TotalComprobante FacturaElectronica/ResumenFactura/TotalDescuentos FacturaElectronica/ResumenFactura/TotalExento FacturaElectronica/ResumenFactura/TotalGravado FacturaElectronica/ResumenFactura/TotalMercanciasExentas FacturaElectronica/ResumenFactura/TotalMercanciasGravadas FacturaElectronica/ResumenFactura/TotalServExentos FacturaElectronica/ResumenFactura/TotalServGravados FacturaElectronica/ResumenFactura/TotalVenta FacturaElectronica/ResumenFactura/TotalVentaNeta	
facets	Kind	Value	Annotation
	totalDigits	18	
	fractionDigits	5	
annotation	documentation	Tipo de dato decimal para representar los valores de dinero.	
source	<pre> <xs:simpleType name="DecimalDineroType"> <xs:annotation> <xs:documentation>Tipo de dato decimal para representar los valores de dinero.</xs:documentation> </xs:annotation> <xs:restriction base="xs:decimal"> <xs:totalDigits value="18"/> <xs:fractionDigits value="5"/> </xs:restriction> </xs:simpleType> </pre>		

simpleType NumeroConsecutivoType

namespace	https://www.hacienda.go.cr/ATV/docs/esquemas/2016/v4/facturaElectronica		
type	restriction of xs:string		
properties	base	xs:string	
used by	element	FacturaElectronica/NumeroConsecutivo	
facets	Kind	Value	Annotation
	pattern	\d{20,20}	
annotation	documentation	Tipo de dato String que solo permite el uso de números con un largo de 50.	
source	<pre> <xs:simpleType name="NumeroConsecutivoType"> <xs:annotation> <xs:documentation>Tipo de dato String que solo permite el uso de números con un largo de 50.</xs:documentation> </xs:annotation> <xs:restriction base="xs:string"> <xs:pattern value="\d{20,20}"/> </xs:restriction> </xs:simpleType> </pre>		

simpleType UnidadMedidaType

namespace	https://www.hacienda.go.cr/ATV/docs/esquemas/2016/v4/facturaElectronica		
type	restriction of xs:string		

properties	base xs:string		
used by	element FacturaElectronica/DetalleServicio/LineaDetalle/UnidadMedida		
facets	Kind	Value	Annotation
	enumeration	Sp	documentation Servicios Profesionales
	enumeration	m	documentation Metro
	enumeration	kg	documentation Kilogramo
	enumeration	s	documentation Segundo
	enumeration	A	documentation Ampere
	enumeration	K	documentation Kelvin
	enumeration	mol	documentation Mol
	enumeration	cd	documentation Candela
	enumeration	m ²	documentation metro cuadrado
	enumeration	m ³	documentation metro cúbico
	enumeration	m/s	documentation metro por segundo
	enumeration	m/s ²	documentation metro por segundo cuadrado
	enumeration	1/m	documentation 1 por metro
	enumeration	kg/m ³	documentation kilogramo por metro cúbico
	enumeration	A/m ²	documentation ampere por metro cuadrado
	enumeration	A/m	documentation ampere por metro
	enumeration	mol/m ³	documentation mol por metro cúbico
	enumeration	cd/m ²	documentation candela por metro cuadrado
	enumeration	1	documentation uno (índice de refracción)
	enumeration	rad	documentation radián
	enumeration	sr	documentation estereorradián
	enumeration	Hz	documentation hertz
	enumeration	N	documentation newton
	enumeration	Pa	documentation pascal
	enumeration	J	documentation Joule
	enumeration	W	documentation Watt
	enumeration	C	documentation coulomb
	enumeration	V	documentation volt
	enumeration	F	documentation farad
	enumeration	Ω	documentation ohm
	enumeration	S	documentation siemens
	enumeration	Wb	documentation weber
	enumeration	T	documentation

enumeration	H	tesla documentation
enumeration	°C	henry documentation
enumeration	lm	grado Celsius documentation
enumeration	lx	lumen documentation
enumeration	Bq	lux documentation
enumeration	Gy	Becquerel documentation
enumeration	Sv	gray documentation
enumeration	kat	sievert documentation
enumeration	Pa·s	katal documentation
enumeration	N·m	pascal segundo documentation
enumeration	N/m	newton metro documentation
enumeration	rad/s	newton por metro documentation
enumeration	rad/s ²	radián por segundo documentation
enumeration	W/m ²	radián por segundo cuadrado documentation
enumeration	J/K	watt por metro cuadrado documentation
enumeration	J/(kg·K)	joule por kelvin documentation
enumeration	J/kg	joule por kilogramo kelvin documentation
enumeration	W/(m·K)	joule por kilogramo documentation
enumeration	J/m ³	watt por metro kevin documentation
enumeration	V/m	joule por metro cúbico documentation
enumeration	C/m ³	volt por metro documentation
enumeration	C/m ²	coulomb por metro cúbico documentation
enumeration	F/m	coulomb por metro cuadrado documentation
enumeration	H/m	farad por metro documentation
enumeration	J/mol	henry por metro documentation
enumeration	J/(mol·K)	joule por mol documentation
enumeration	C/kg	joule por mol kelvin documentation
enumeration	Gy/s	coulomb por kilogramo documentation
enumeration	W/sr	gray por segundo documentation
enumeration	W/(m ² ·sr)	watt por estereorradián documentation
enumeration	kat/m ³	watt por metro cuadrado estereorradián documentation
enumeration	min	katal por metro cúbico documentation
enumeration	h	minuto documentation
enumeration	d	hora documentation
enumeration	°	día documentation
enumeration	°	documentation

	<p>enumeration ' grado documentation minuto</p> <p>enumeration '' documentation segundo</p> <p>enumeration L documentation litro</p> <p>enumeration t documentation tonelada</p> <p>enumeration Np documentation neper</p> <p>enumeration B documentation bel</p> <p>enumeration eV documentation electronvolt</p> <p>enumeration u documentation unidad de masa atómica unificada</p> <p>enumeration ua documentation unidad astronómica</p> <p>enumeration Unid documentation unidad</p> <p>enumeration Gal documentation galón</p> <p>enumeration g documentation gramo</p> <p>enumeration Km documentation kilometro</p> <p>enumeration In documentation pulgada</p> <p>enumeration cm documentation centimetro</p> <p>enumeration mL documentation mililitro</p> <p>enumeration mm documentation milimetro</p> <p>enumeration Oz documentation onzas</p> <p>enumeration Otros</p>
annotation	documentation Unidades de Medida basadas en el estándar RTC 443:2010
source	<pre> <xs:simpleType name="UnidadMedidaType"> <xs:annotation> <xs:documentation>Unidades de Medida basadas en el estándar RTC 443:2010</xs:documentation> </xs:annotation> <xs:restriction base="xs:string"> <xs:enumeration value="Sp"> <xs:annotation> <xs:documentation>Servicios Profesionales</xs:documentation> </xs:annotation> </xs:enumeration> <xs:enumeration value="m"> <xs:annotation> <xs:documentation>Metro</xs:documentation> </xs:annotation> </xs:enumeration> <xs:enumeration value="kg"> <xs:annotation> <xs:documentation>Kilogramo</xs:documentation> </xs:annotation> </xs:enumeration> <xs:enumeration value="s"> <xs:annotation> </pre>

```
<xs:documentation>Segundo</xs:documentation>
</xs:annotation>
</xs:enumeration>
<xs:enumeration value="A">
  <xs:annotation>
    <xs:documentation>Ampere</xs:documentation>
  </xs:annotation>
</xs:enumeration>
<xs:enumeration value="K">
  <xs:annotation>
    <xs:documentation>Kelvin</xs:documentation>
  </xs:annotation>
</xs:enumeration>
<xs:enumeration value="mol">
  <xs:annotation>
    <xs:documentation>Mol</xs:documentation>
  </xs:annotation>
</xs:enumeration>
<xs:enumeration value="cd">
  <xs:annotation>
    <xs:documentation>Candela</xs:documentation>
  </xs:annotation>
</xs:enumeration>
<xs:enumeration value="m2">
  <xs:annotation>
    <xs:documentation>metro cuadrado</xs:documentation>
  </xs:annotation>
</xs:enumeration>
<xs:enumeration value="m3">
  <xs:annotation>
    <xs:documentation>metro cúbico</xs:documentation>
  </xs:annotation>
</xs:enumeration>
<xs:enumeration value="m/s">
  <xs:annotation>
    <xs:documentation>metro por segundo</xs:documentation>
  </xs:annotation>
</xs:enumeration>
<xs:enumeration value="m/s2">
  <xs:annotation>
    <xs:documentation>metro por segundo cuadrado</xs:documentation>
  </xs:annotation>
</xs:enumeration>
<xs:enumeration value="1/m">
  <xs:annotation>
    <xs:documentation>1 por metro</xs:documentation>
  </xs:annotation>
</xs:enumeration>
<xs:enumeration value="kg/m3">
  <xs:annotation>
    <xs:documentation>kilogramo por metro cúbico</xs:documentation>
  </xs:annotation>
</xs:enumeration>
<xs:enumeration value="A/m2">
  <xs:annotation>
    <xs:documentation>ampere por metro cuadrado</xs:documentation>
  </xs:annotation>
</xs:enumeration>
```

```
</xs:annotation>
</xs:enumeration>
<xs:enumeration value="A/m">
  <xs:annotation>
    <xs:documentation>ampere por metro</xs:documentation>
  </xs:annotation>
</xs:enumeration>
<xs:enumeration value="mol/m³">
  <xs:annotation>
    <xs:documentation>mol por metro cúbico</xs:documentation>
  </xs:annotation>
</xs:enumeration>
<xs:enumeration value="cd/m²">
  <xs:annotation>
    <xs:documentation>candela por metro cuadrado</xs:documentation>
  </xs:annotation>
</xs:enumeration>
<xs:enumeration value="1">
  <xs:annotation>
    <xs:documentation>uno (índice de refracción)</xs:documentation>
  </xs:annotation>
</xs:enumeration>
<xs:enumeration value="rad">
  <xs:annotation>
    <xs:documentation>radián</xs:documentation>
  </xs:annotation>
</xs:enumeration>
<xs:enumeration value="sr">
  <xs:annotation>
    <xs:documentation>estereorradián</xs:documentation>
  </xs:annotation>
</xs:enumeration>
<xs:enumeration value="Hz">
  <xs:annotation>
    <xs:documentation>hertz</xs:documentation>
  </xs:annotation>
</xs:enumeration>
<xs:enumeration value="N">
  <xs:annotation>
    <xs:documentation>newton</xs:documentation>
  </xs:annotation>
</xs:enumeration>
<xs:enumeration value="Pa">
  <xs:annotation>
    <xs:documentation>pascal</xs:documentation>
  </xs:annotation>
</xs:enumeration>
<xs:enumeration value="J">
  <xs:annotation>
    <xs:documentation>Joule</xs:documentation>
  </xs:annotation>
</xs:enumeration>
<xs:enumeration value="W">
  <xs:annotation>
    <xs:documentation>Watt</xs:documentation>
  </xs:annotation>
</xs:annotation>
```

```
</xs:enumeration>
<xs:enumeration value="C">
  <xs:annotation>
    <xs:documentation>coulomb</xs:documentation>
  </xs:annotation>
</xs:enumeration>
<xs:enumeration value="V">
  <xs:annotation>
    <xs:documentation>volt</xs:documentation>
  </xs:annotation>
</xs:enumeration>
<xs:enumeration value="F">
  <xs:annotation>
    <xs:documentation>farad</xs:documentation>
  </xs:annotation>
</xs:enumeration>
<xs:enumeration value="Ω">
  <xs:annotation>
    <xs:documentation>ohm</xs:documentation>
  </xs:annotation>
</xs:enumeration>
<xs:enumeration value="S">
  <xs:annotation>
    <xs:documentation>siemens</xs:documentation>
  </xs:annotation>
</xs:enumeration>
<xs:enumeration value="Wb">
  <xs:annotation>
    <xs:documentation>weber</xs:documentation>
  </xs:annotation>
</xs:enumeration>
<xs:enumeration value="T">
  <xs:annotation>
    <xs:documentation>tesla</xs:documentation>
  </xs:annotation>
</xs:enumeration>
<xs:enumeration value="H">
  <xs:annotation>
    <xs:documentation>henry</xs:documentation>
  </xs:annotation>
</xs:enumeration>
<xs:enumeration value="°C">
  <xs:annotation>
    <xs:documentation>grado Celsius</xs:documentation>
  </xs:annotation>
</xs:enumeration>
<xs:enumeration value="lm">
  <xs:annotation>
    <xs:documentation>lumen</xs:documentation>
  </xs:annotation>
</xs:enumeration>
<xs:enumeration value="lx">
  <xs:annotation>
    <xs:documentation>lux</xs:documentation>
  </xs:annotation>
</xs:enumeration>
```

```
<xs:enumeration value="Bq">
  <xs:annotation>
    <xs:documentation>Becquerel</xs:documentation>
  </xs:annotation>
</xs:enumeration>
<xs:enumeration value="Gy">
  <xs:annotation>
    <xs:documentation>gray</xs:documentation>
  </xs:annotation>
</xs:enumeration>
<xs:enumeration value="Sv">
  <xs:annotation>
    <xs:documentation>sievert</xs:documentation>
  </xs:annotation>
</xs:enumeration>
<xs:enumeration value="kat">
  <xs:annotation>
    <xs:documentation>katal</xs:documentation>
  </xs:annotation>
</xs:enumeration>
<xs:enumeration value="Pa·s">
  <xs:annotation>
    <xs:documentation>pascal segundo</xs:documentation>
  </xs:annotation>
</xs:enumeration>
<xs:enumeration value="N·m">
  <xs:annotation>
    <xs:documentation>newton metro</xs:documentation>
  </xs:annotation>
</xs:enumeration>
<xs:enumeration value="N/m">
  <xs:annotation>
    <xs:documentation>newton por metro</xs:documentation>
  </xs:annotation>
</xs:enumeration>
<xs:enumeration value="rad/s">
  <xs:annotation>
    <xs:documentation>radián por segundo</xs:documentation>
  </xs:annotation>
</xs:enumeration>
<xs:enumeration value="rad/s²">
  <xs:annotation>
    <xs:documentation>radián por segundo cuadrado</xs:documentation>
  </xs:annotation>
</xs:enumeration>
<xs:enumeration value="W/m²">
  <xs:annotation>
    <xs:documentation>watt por metro cuadrado</xs:documentation>
  </xs:annotation>
</xs:enumeration>
<xs:enumeration value="J/K">
  <xs:annotation>
    <xs:documentation>joule por kelvin</xs:documentation>
  </xs:annotation>
</xs:enumeration>
<xs:enumeration value="J/(kg·K)">
```

```
<xs:annotation>
  <xs:documentation>joule por kilogramo kelvin</xs:documentation>
</xs:annotation>
</xs:enumeration>
<xs:enumeration value="J/kg">
  <xs:annotation>
    <xs:documentation>joule por kilogramo</xs:documentation>
  </xs:annotation>
</xs:enumeration>
<xs:enumeration value="W/(m·K)">
  <xs:annotation>
    <xs:documentation>watt por metro kevin</xs:documentation>
  </xs:annotation>
</xs:enumeration>
<xs:enumeration value="J/m³">
  <xs:annotation>
    <xs:documentation>joule por metro cúbico</xs:documentation>
  </xs:annotation>
</xs:enumeration>
<xs:enumeration value="V/m">
  <xs:annotation>
    <xs:documentation>volt por metro</xs:documentation>
  </xs:annotation>
</xs:enumeration>
<xs:enumeration value="C/m³">
  <xs:annotation>
    <xs:documentation>coulomb por metro cúbico</xs:documentation>
  </xs:annotation>
</xs:enumeration>
<xs:enumeration value="C/m²">
  <xs:annotation>
    <xs:documentation>coulomb por metro cuadrado</xs:documentation>
  </xs:annotation>
</xs:enumeration>
<xs:enumeration value="F/m">
  <xs:annotation>
    <xs:documentation>farad por metro</xs:documentation>
  </xs:annotation>
</xs:enumeration>
<xs:enumeration value="H/m">
  <xs:annotation>
    <xs:documentation>henry por metro</xs:documentation>
  </xs:annotation>
</xs:enumeration>
<xs:enumeration value="J/mol">
  <xs:annotation>
    <xs:documentation>joule por mol</xs:documentation>
  </xs:annotation>
</xs:enumeration>
<xs:enumeration value="J/(mol·K)">
  <xs:annotation>
    <xs:documentation>joule por mol kelvin</xs:documentation>
  </xs:annotation>
</xs:enumeration>
<xs:enumeration value="C/kg">
  <xs:annotation>
```

```
<xs:documentation>coulomb por kilogramo</xs:documentation>
</xs:annotation>
</xs:enumeration>
<xs:enumeration value="Gy/s">
  <xs:annotation>
    <xs:documentation>gray por segundo</xs:documentation>
  </xs:annotation>
</xs:enumeration>
<xs:enumeration value="W/sr">
  <xs:annotation>
    <xs:documentation>watt por estereorradián</xs:documentation>
  </xs:annotation>
</xs:enumeration>
<xs:enumeration value="W/(m²·sr)">
  <xs:annotation>
    <xs:documentation>watt por metro cuadrado estereorradián</xs:documentation>
  </xs:annotation>
</xs:enumeration>
<xs:enumeration value="kat/m³">
  <xs:annotation>
    <xs:documentation>katal por metro cúbico</xs:documentation>
  </xs:annotation>
</xs:enumeration>
<xs:enumeration value="min">
  <xs:annotation>
    <xs:documentation>minuto</xs:documentation>
  </xs:annotation>
</xs:enumeration>
<xs:enumeration value="h">
  <xs:annotation>
    <xs:documentation>hora</xs:documentation>
  </xs:annotation>
</xs:enumeration>
<xs:enumeration value="d">
  <xs:annotation>
    <xs:documentation>día</xs:documentation>
  </xs:annotation>
</xs:enumeration>
<xs:enumeration value="°">
  <xs:annotation>
    <xs:documentation>grado</xs:documentation>
  </xs:annotation>
</xs:enumeration>
<xs:enumeration value="′">
  <xs:annotation>
    <xs:documentation>minuto</xs:documentation>
  </xs:annotation>
</xs:enumeration>
<xs:enumeration value="″">
  <xs:annotation>
    <xs:documentation>segundo</xs:documentation>
  </xs:annotation>
</xs:enumeration>
<xs:enumeration value="L">
  <xs:annotation>
    <xs:documentation>litro</xs:documentation>
  </xs:annotation>
</xs:enumeration>
```

```
</xs:annotation>
</xs:enumeration>
<xs:enumeration value="t">
  <xs:annotation>
    <xs:documentation>tonelada</xs:documentation>
  </xs:annotation>
</xs:enumeration>
<xs:enumeration value="Np">
  <xs:annotation>
    <xs:documentation>neper</xs:documentation>
  </xs:annotation>
</xs:enumeration>
<xs:enumeration value="B">
  <xs:annotation>
    <xs:documentation>bel</xs:documentation>
  </xs:annotation>
</xs:enumeration>
<xs:enumeration value="eV">
  <xs:annotation>
    <xs:documentation>electronvolt</xs:documentation>
  </xs:annotation>
</xs:enumeration>
<xs:enumeration value="u">
  <xs:annotation>
    <xs:documentation>unidad de masa atómica unificada</xs:documentation>
  </xs:annotation>
</xs:enumeration>
<xs:enumeration value="ua">
  <xs:annotation>
    <xs:documentation>unidad astronómica</xs:documentation>
  </xs:annotation>
</xs:enumeration>
<xs:enumeration value="Unid">
  <xs:annotation>
    <xs:documentation>unidad</xs:documentation>
  </xs:annotation>
</xs:enumeration>
<xs:enumeration value="Gal">
  <xs:annotation>
    <xs:documentation>galón</xs:documentation>
  </xs:annotation>
</xs:enumeration>
<xs:enumeration value="g">
  <xs:annotation>
    <xs:documentation>gramo</xs:documentation>
  </xs:annotation>
</xs:enumeration>
<xs:enumeration value="Km">
  <xs:annotation>
    <xs:documentation>kilometro</xs:documentation>
  </xs:annotation>
</xs:enumeration>
<xs:enumeration value="In">
  <xs:annotation>
    <xs:documentation>pulgada</xs:documentation>
  </xs:annotation>
</xs:annotation>
```

```

</xs:enumeration>
<xs:enumeration value="cm">
  <xs:annotation>
    <xs:documentation>centimetro</xs:documentation>
  </xs:annotation>
</xs:enumeration>
<xs:enumeration value="mL">
  <xs:annotation>
    <xs:documentation>mililitro</xs:documentation>
  </xs:annotation>
</xs:enumeration>
<xs:enumeration value="mm">
  <xs:annotation>
    <xs:documentation>milimetro</xs:documentation>
  </xs:annotation>
</xs:enumeration>
<xs:enumeration value="Oz">
  <xs:annotation>
    <xs:documentation>onzas</xs:documentation>
  </xs:annotation>
</xs:enumeration>
<xs:enumeration value="Otros">
  <xs:annotation>
    <xs:documentation/>
  </xs:annotation>
</xs:enumeration>
</xs:restriction>
</xs:simpleType>

```

element **CanonicalizationMethod**

diagram						
namespace	http://www.w3.org/2000/09/xmldsig#					
type	ds:CanonicalizationMethodType					
properties	content	complex				
	mixed	true				
used by	complexType	SignedInfoType				
attributes	Name	Type	Use	Default	Fixed	Annotation
	Algorithm	xs:anyURI	required			
source	<xs:element name="CanonicalizationMethod" type="ds:CanonicalizationMethodType"/>					

element DigestMethod

diagram						
namespace	http://www.w3.org/2000/09/xmldsig#					
type	ds:DigestMethodType					
properties	content	complex				
	mixed	true				
used by	complexType	ReferenceType				
attributes	Name	Type	Use	Default	Fixed	Annotation
	Algorithm	xs:anyURI	required			
source	<code><xs:element name="DigestMethod" type="ds:DigestMethodType"/></code>					

element DigestValue

diagram						
namespace	http://www.w3.org/2000/09/xmldsig#					
type	ds:DigestValueType					
properties	content	simple				
used by	complexType	ReferenceType				
source	<code><xs:element name="DigestValue" type="ds:DigestValueType"/></code>					

element **DSAKeyValue**

<p>diagram</p>	
<p>namespace</p>	<p>http://www.w3.org/2000/09/xmldsig#</p>
<p>type</p>	<p>ds:DSAKeyValue Type</p>
<p>properties</p>	<p>content complex</p>
<p>children</p>	<p>ds:P ds:Q ds:G ds:Y ds:J ds:Seed ds:PgenCounter</p>
<p>used by</p>	<p>complexType KeyValue Type</p>
<p>source</p>	<p><code><xs:element name="DSAKeyValue" type="ds:DSAKeyValue Type"/></code></p>

element **KeyInfo**

diagram						
namespace	http://www.w3.org/2000/09/xmldsig#					
type	ds:KeyInfoType					
properties	content	mixed	complex	true		
children	ds:KeyName ds:KeyValue ds:RetrievalMethod ds:X509Data ds:PGPData ds:SPKIDData ds:MgmtData					
used by	complexType	SignatureType				
attributes	Name	Type	Use	Default	Fixed	Annotation
	Id	xs:ID	optional			
source	<code><xs:element name="KeyInfo" type="ds:KeyInfoType"/></code>					

element **KeyName**

diagram						
namespace	http://www.w3.org/2000/09/xmldsig#					
type	xs:string					
properties	content	simple				
used by	complexType	KeyInfoType				
source	<code><xs:element name="KeyName" type="string"/></code>					

element **KeyValue**

diagram	
namespace	http://www.w3.org/2000/09/xmldsig#
type	ds:KeyValue
properties	content complex mixed true
children	ds:DSAKeyValue ds:RSAKeyValue
used by	complexType KeyInfoType
source	<code><xs:element name="KeyValue" type="ds:KeyValueType"/></code>

element **Manifest**

diagram													
namespace	http://www.w3.org/2000/09/xmldsig#												
type	ds:Manifest												
properties	content complex												
children	ds:Reference												
attributes	<table border="1"> <thead> <tr> <th>Name</th> <th>Type</th> <th>Use</th> <th>Default</th> <th>Fixed</th> <th>Annotation</th> </tr> </thead> <tbody> <tr> <td>Id</td> <td>xs:ID</td> <td>optional</td> <td></td> <td></td> <td></td> </tr> </tbody> </table>	Name	Type	Use	Default	Fixed	Annotation	Id	xs:ID	optional			
Name	Type	Use	Default	Fixed	Annotation								
Id	xs:ID	optional											
source	<code><xs:element name="Manifest" type="ds:ManifestType"/></code>												

element **MgmtData**

diagram	
namespace	http://www.w3.org/2000/09/xmldsig#
type	xs:string
properties	content simple

used by	complexType KeyInfoType
source	<code><xs:element name="MgmtData" type="string"/></code>

element Object

diagram						
namespace	http://www.w3.org/2000/09/xmldsig#					
type	ds:ObjectType					
properties	content	complexType				
	mixed	true				
used by	complexType	SignatureType				
attributes	Name	Type	Use	Default	Fixed	Annotation
	Id	xs:ID	optional			
	MimeType	xs:string	optional			
	Encoding	xs:anyURI	optional			
source	<code><xs:element name="Object" type="ds:ObjectType"/></code>					

element PGPData

diagram						
namespace	http://www.w3.org/2000/09/xmldsig#					

type	ds:PGPDataType
properties	content complex
children	ds:PGPKeyID ds:PGPKeyPacket ds:PGPKeyPacket
used by	complexType KeyInfoType
source	<code><xs:element name="PGPData" type="ds:PGPDataType"/></code>

element Reference

diagram	<p>The diagram illustrates the structure of the <code>ds:ReferenceType</code>. It shows a central <code>Reference</code> element connected to an <code>attributes</code> container. The <code>attributes</code> container includes <code>Id</code>, <code>URI</code>, and <code>Type</code>. Below the <code>Reference</code> element is a container box that includes <code>ds:Transforms</code>, <code>ds:DigestMethod</code>, and <code>ds:DigestValue</code>.</p>																								
namespace	http://www.w3.org/2000/09/xmldsig#																								
type	ds:ReferenceType																								
properties	content complex																								
children	ds:Transforms ds:DigestMethod ds:DigestValue																								
used by	complexTypes ManifestType SignedInfoType																								
attributes	<table border="1"> <thead> <tr> <th>Name</th> <th>Type</th> <th>Use</th> <th>Default</th> <th>Fixed</th> <th>Annotation</th> </tr> </thead> <tbody> <tr> <td>Id</td> <td>xs:ID</td> <td>optional</td> <td></td> <td></td> <td></td> </tr> <tr> <td>URI</td> <td>xs:anyURI</td> <td>optional</td> <td></td> <td></td> <td></td> </tr> <tr> <td>Type</td> <td>xs:anyURI</td> <td>optional</td> <td></td> <td></td> <td></td> </tr> </tbody> </table>	Name	Type	Use	Default	Fixed	Annotation	Id	xs:ID	optional				URI	xs:anyURI	optional				Type	xs:anyURI	optional			
Name	Type	Use	Default	Fixed	Annotation																				
Id	xs:ID	optional																							
URI	xs:anyURI	optional																							
Type	xs:anyURI	optional																							
source	<code><xs:element name="Reference" type="ds:ReferenceType"/></code>																								

element RetrievalMethod

diagram						
namespace	http://www.w3.org/2000/09/xmlsig#					
type	ds:RetrievalMethodType					
properties	content complex					
children	ds:Transforms					
used by	complexType KeyInfoType					
attributes	Name	Type	Use	Default	Fixed	Annotation
	URI	xs:anyURI				
	Type	xs:anyURI	optional			
source	<code><xs:element name="RetrievalMethod" type="ds:RetrievalMethodType"/></code>					

element RSAKeyValue

diagram						
namespace	http://www.w3.org/2000/09/xmlsig#					
type	ds:RSAKeyValue Type					
properties	content complex					
children	ds:Modulus ds:Exponent					
used by	complexType KeyValue Type					
source	<code><xs:element name="RSAKeyValue" type="ds:RSAKeyValue Type"/></code>					

element **Signature**

diagram							
namespace	http://www.w3.org/2000/09/xmldsig#						
type	ds:SignatureType						
properties	content complex						
children	ds:SignedInfo ds:SignatureValue ds:KeyInfo ds:Object						
used by	element FacturaElectronica						
attributes	Name	Type	Use	Default	Fixed	Use	Annotation
	Id	xs:ID	optional				
source	<xs:element name="Signature" type="ds:SignatureType"/>						

element **SignatureMethod**

diagram							
namespace	http://www.w3.org/2000/09/xmldsig#						
type	ds:SignatureMethodType						
properties	content complex mixed true						
children	ds:HMACOutputLength						
used by	complexType SignedInfoType						

attributes	Name Algorithm	Type xs:anyURI	Use required	Default	Fixed	Annotation
source	<code><xs:element name="SignatureMethod" type="ds:SignatureMethodType"/></code>					

element **SignatureProperties**

diagram						
namespace	http://www.w3.org/2000/09/xmldsig#					
type	ds:SignaturePropertiesType					
properties	content complex					
children	ds:SignatureProperty					
attributes	Name Id	Type xs:ID	Use optional	Default	Fixed	Annotation
source	<code><xs:element name="SignatureProperties" type="ds:SignaturePropertiesType"/></code>					

element **SignatureProperty**

diagram						
namespace	http://www.w3.org/2000/09/xmldsig#					
type	ds:SignaturePropertyType					
properties	content complex mixed true					
used by	complexType SignaturePropertiesType					
attributes	Name Target	Type xs:anyURI	Use required	Default	Fixed	Annotation
	Id	xs:ID	optional			

source	<code><xs:element name="SignatureProperty" type="ds:SignaturePropertyType"/></code>
--------	-------------------------------------------------------------------------------------------

element **SignatureValue**

diagram						
namespace	http://www.w3.org/2000/09/xmldsig#					
type	ds:SignatureValueType					
properties	content complex					
used by	complexType SignatureType					
attributes	Name	Type	Use	Default	Fixed	Annotation
	Id	xs:ID	optional			
source	<code><xs:element name="SignatureValue" type="ds:SignatureValueType"/></code>					

element **SignedInfo**

diagram						
namespace	http://www.w3.org/2000/09/xmldsig#					
type	ds:SIGNEDInfoType					
properties	content complex					
children	ds:CanonicalizationMethod ds:SignatureMethod ds:Reference					
used by	complexType SignatureType					
attributes	Name	Type	Use	Default	Fixed	Annotation
	Id	xs:ID	optional			
source	<code><xs:element name="SignedInfo" type="ds:SIGNEDInfoType"/></code>					

element SPKIData

diagram	
namespace	http://www.w3.org/2000/09/xmldsig#
type	ds:SPKIDataType
properties	content complex
children	ds:SPKISexp
used by	complexType KeyInfoType
source	<code><xs:element name="SPKIData" type="ds:SPKIDataType"/></code>

element Transform

diagram													
namespace	http://www.w3.org/2000/09/xmldsig#												
type	ds:TransformType												
properties	content complex mixed true												
children	ds:XPath												
used by	complexType TransformsType												
attributes	<table border="1"> <thead> <tr> <th>Name</th> <th>Type</th> <th>Use</th> <th>Default</th> <th>Fixed</th> <th>Annotation</th> </tr> </thead> <tbody> <tr> <td>Algorithm</td> <td>xs:anyURI</td> <td>required</td> <td></td> <td></td> <td></td> </tr> </tbody> </table>	Name	Type	Use	Default	Fixed	Annotation	Algorithm	xs:anyURI	required			
Name	Type	Use	Default	Fixed	Annotation								
Algorithm	xs:anyURI	required											
source	<code><xs:element name="Transform" type="ds:TransformType"/></code>												

element **Transforms**

diagram	
namespace	http://www.w3.org/2000/09/xmldsig#
type	ds:TransformsType
properties	content complex
children	ds:Transform
used by	complexTypees ReferenceType RetrievalMethodType
source	<code><xs:element name="Transforms" type="ds:TransformsType"/></code>

element **X509Data**

diagram	
namespace	http://www.w3.org/2000/09/xmldsig#
type	ds:X509DataType
properties	content complex
children	ds:X509IssuerSerial ds:X509SKI ds:X509SubjectName ds:X509Certificate ds:X509CRL
used by	complexType KeyInfoType
source	<code><xs:element name="X509Data" type="ds:X509DataType"/></code>

complexType CanonicalizationMethodType

diagram						
namespace	http://www.w3.org/2000/09/xmldsig#					
properties	mixed true					
used by	element CanonicalizationMethod					
attributes	Name	Type	Use	Default	Fixed	Annotation
	Algorithm	xs:anyURI	required			
source	<pre><xs:complexType name="CanonicalizationMethodType" mixed="true"> <xs:sequence> <xs:any namespace="##any" minOccurs="0" maxOccurs="unbounded"/> <!-- (0,unbounded) elements from (1,1) namespace --> </xs:sequence> <xs:attribute name="Algorithm" type="anyURI" use="required"/> </xs:complexType></pre>					

attribute CanonicalizationMethodType/@Algorithm

type	xs:anyURI
properties	use required
source	<pre><xs:attribute name="Algorithm" type="anyURI" use="required"/></pre>

complexType DigestMethodType

diagram						
namespace	http://www.w3.org/2000/09/xmldsig#					
properties	mixed true					
used by	element DigestMethod					
attributes	Name	Type	Use	Default	Fixed	Annotation
	Algorithm	xs:anyURI	required			
source	<pre><xs:complexType name="DigestMethodType" mixed="true"> <xs:sequence> <xs:any namespace="##other" processContents="lax" minOccurs="0" maxOccurs="unbounded"/> </xs:sequence></pre>					

```
<xs:attribute name="Algorithm" type="anyURI" use="required"/>
</xs:complexType>
```

attribute **DigestMethodType/@Algorithm**

type	xs:anyURI
properties	use required
source	<xs:attribute name="Algorithm" type="anyURI" use="required"/>

complexType **DSAKeyValue**

diagram	
namespace	http://www.w3.org/2000/09/xmldsig#
children	ds:P ds:Q ds:G ds:Y ds:J ds:Seed ds:PgenCounter
used by	element DSAKeyValue
source	<pre><xs:complexType name="DSAKeyValue"> <xs:sequence> <xs:sequence minOccurs="0"> <xs:element name="P" type="ds:CryptoBinary"/> <xs:element name="Q" type="ds:CryptoBinary"/> </xs:sequence> <xs:element name="G" type="ds:CryptoBinary" minOccurs="0"/> <xs:element name="Y" type="ds:CryptoBinary"/> <xs:element name="J" type="ds:CryptoBinary" minOccurs="0"/> <xs:sequence minOccurs="0"> <xs:element name="Seed" type="ds:CryptoBinary"/> <xs:element name="PgenCounter" type="ds:CryptoBinary"/> </xs:sequence> </xs:sequence> </xs:complexType></pre>

element **DSAKeyValue/P**

diagram	
namespace	http://www.w3.org/2000/09/xmldsig#
type	ds:CryptBinary
properties	content simple
source	<code><xs:element name="P" type="ds:CryptBinary"/></code>

element **DSAKeyValue/Q**

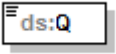
diagram	
namespace	http://www.w3.org/2000/09/xmldsig#
type	ds:CryptBinary
properties	content simple
source	<code><xs:element name="Q" type="ds:CryptBinary"/></code>

element **DSAKeyValue/G**

diagram	
namespace	http://www.w3.org/2000/09/xmldsig#
type	ds:CryptBinary
properties	minOcc 0 maxOcc 1 content simple
source	<code><xs:element name="G" type="ds:CryptBinary minOccurs="0"/></code>

element **DSAKeyValue/Y**

diagram	
namespace	http://www.w3.org/2000/09/xmldsig#
type	ds:CryptBinary
properties	content simple
source	<code><xs:element name="Y" type="ds:CryptBinary"/></code>

element **DSAKeyValue/J**

diagram	
---------	-------------------------------------------------------------------------------------

namespace	http://www.w3.org/2000/09/xmldsig#
type	ds:CryptoBinary
properties	minOcc 0 maxOcc 1 content simple
source	<xs:element name="J" type="ds:CryptoBinary" minOccurs="0"/>

element **DSAKeyValue/Seed**

diagram	 A diagram showing a rectangular box with a small icon on the left and the text "ds:Seed" inside.
namespace	http://www.w3.org/2000/09/xmldsig#
type	ds:CryptoBinary
properties	content simple
source	<xs:element name="Seed" type="ds:CryptoBinary"/>

element **DSAKeyValue/PgenCounter**

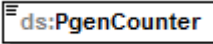
diagram	 A diagram showing a rectangular box with a small icon on the left and the text "ds:PgenCounter" inside.
namespace	http://www.w3.org/2000/09/xmldsig#
type	ds:CryptoBinary
properties	content simple
source	<xs:element name="PgenCounter" type="ds:CryptoBinary"/>

complexType KeyInfoType

diagram							
namespace	http://www.w3.org/2000/09/xmldsig#						
properties	mixed true						
children	ds:KeyName ds:KeyValue ds:RetrievalMethod ds:X509Data ds:PGPData ds:SPKIData ds:MgmtData						
used by	element KeyInfo						
attributes	Name	Type	Use	Default	Fixed	Annotation	
	Id	xs:ID	optional				
source	<pre> <xs:complexType name="KeyInfoType" mixed="true"> <xs:choice maxOccurs="unbounded"> <xs:element ref="ds:KeyName"/> <xs:element ref="ds:KeyValue"/> <xs:element ref="ds:RetrievalMethod"/> <xs:element ref="ds:X509Data"/> <xs:element ref="ds:PGPData"/> <xs:element ref="ds:SPKIData"/> <xs:element ref="ds:MgmtData"/> <xs:any namespace="##other" processContents="lax"/> <!-- (1,1) elements from (0,unbounded) namespaces --> </xs:choice> <xs:attribute name="Id" type="ID" use="optional"/> </xs:complexType> </pre>						

attribute KeyInfoType/@Id

type	xs:ID
properties	use optional
source	<xs:attribute name="Id" type="ID" use="optional"/>

complexType KeyValue

diagram	
namespace	http://www.w3.org/2000/09/xmldsig#
properties	mixed true
children	ds:DSAKeyValue ds:RSAKeyValue
used by	element KeyValue
source	<pre><xs:complexType name="KeyValue" mixed="true"> <xs:choice> <xs:element ref="ds:DSAKeyValue"/> <xs:element ref="ds:RSAKeyValue"/> <xs:any namespace="##other" processContents="lax"/> </xs:choice> </xs:complexType></pre>

complexType Manifest

diagram													
namespace	http://www.w3.org/2000/09/xmldsig#												
children	ds:Reference												
used by	element Manifest												
attributes	<table border="1"> <thead> <tr> <th>Name</th> <th>Type</th> <th>Use</th> <th>Default</th> <th>Fixed</th> <th>Annotation</th> </tr> </thead> <tbody> <tr> <td>Id</td> <td>xs:ID</td> <td>optional</td> <td></td> <td></td> <td></td> </tr> </tbody> </table>	Name	Type	Use	Default	Fixed	Annotation	Id	xs:ID	optional			
Name	Type	Use	Default	Fixed	Annotation								
Id	xs:ID	optional											
source	<pre><xs:complexType name="Manifest"> <xs:sequence> <xs:element ref="ds:Reference" maxOccurs="unbounded"/> </xs:sequence> <xs:attribute name="Id" type="ID" use="optional"/> </xs:complexType></pre>												

attribute Manifest/@Id

type	xs:ID
properties	use optional

source	<code><xs:attribute name="Id" type="ID" use="optional"/></code>
--------	-----------------------------------------------------------------------

complexType **ObjectType**

diagram						
namespace	http://www.w3.org/2000/09/xmldsig#					
properties	mixed true					
used by	element Object					
attributes	Name	Type	Use	Default	Fixed	Annotation
	Id	xs:ID	optional			
	MimeType	xs:string	optional			
	Encoding	xs:anyURI	optional			
source	<pre> <xs:complexType name="ObjectType" mixed="true"> <xs:sequence minOccurs="0" maxOccurs="unbounded"> <xs:any namespace="##any" processContents="lax"/> </xs:sequence> <xs:attribute name="Id" type="ID" use="optional"/> <xs:attribute name="MimeType" type="string" use="optional"/> <xs:attribute name="Encoding" type="anyURI" use="optional"/> <!-- add a grep facet --> </xs:complexType> </pre>					

attribute **ObjectType/@Id**

type	xs:ID
properties	use optional
source	<code><xs:attribute name="Id" type="ID" use="optional"/></code>

attribute **ObjectType/@MimeType**

type	xs:string
properties	use optional
source	<code><xs:attribute name="MimeType" type="string" use="optional"/></code>

attribute **ObjectType/@Encoding**

type	xs:anyURI
properties	use optional
source	<xs:attribute name="Encoding" type="anyURI" use="optional"/>

complexType **PGPDataType**

diagram	
namespace	http://www.w3.org/2000/09/xmldsig#
children	ds:PGPKeyID ds:PGPKeyPacket ds:PGPKeyPacket
used by	element PGPData
source	<pre> <xs:complexType name="PGPDataType"> <xs:choice> <xs:sequence> <xs:element name="PGPKeyID" type="base64Binary"/> <xs:element name="PGPKeyPacket" type="base64Binary" minOccurs="0"/> <xs:any namespace="##other" processContents="lax" minOccurs="0" maxOccurs="unbounded"/> </xs:sequence> <xs:sequence> <xs:element name="PGPKeyPacket" type="base64Binary"/> <xs:any namespace="##other" processContents="lax" minOccurs="0" maxOccurs="unbounded"/> </xs:sequence> </xs:choice> </xs:complexType> </pre>

element **PGPDataType/PGPKeyID**

diagram	
namespace	http://www.w3.org/2000/09/xmldsig#
type	xs:base64Binary
properties	content simple
source	<xs:element name="PGPKeyID" type="base64Binary"/>

element **PGPDataType/PGPKeyPacket**

diagram	
namespace	http://www.w3.org/2000/09/xmldsig#
type	xs:base64Binary
properties	minOcc 0 maxOcc 1 content simple
source	<code><xs:element name="PGPKeyPacket" type="base64Binary" minOccurs="0"/></code>

element **PGPDataType/PGPKeyPacket**

diagram	
namespace	http://www.w3.org/2000/09/xmldsig#
type	xs:base64Binary
properties	content simple
source	<code><xs:element name="PGPKeyPacket" type="base64Binary"/></code>

complexType **ReferenceType**

diagram							
namespace	http://www.w3.org/2000/09/xmldsig#						
children	ds:Transforms ds:DigestMethod ds:DigestValue						
used by	element Reference						
attributes	Name	Type	Use	Default	Fixed	Annotation	
	Id	xs:ID	optional				
	URI	xs:anyURI	optional				
	Type	xs:anyURI	optional				
source	<code><xs:complexType name="ReferenceType"></code>						

	<pre> <xs:sequence> <xs:element ref="ds:Transforms" minOccurs="0"/> <xs:element ref="ds:DigestMethod"/> <xs:element ref="ds:DigestValue"/> </xs:sequence> <xs:attribute name="Id" type="ID" use="optional"/> <xs:attribute name="URI" type="anyURI" use="optional"/> <xs:attribute name="Type" type="anyURI" use="optional"/> </xs:complexType> </pre>
--	--------------------------------------------------------------------------------------------------------------------------------------------------------------------------------------------------------------------------------------------------------------------------------------------------------------------------------------------------------------------------------------------------------------------

attribute ReferenceType/@Id

type	xs:ID
properties	use optional
source	<code><xs:attribute name="Id" type="ID" use="optional"/></code>

attribute ReferenceType/@URI

type	xs:anyURI
properties	use optional
source	<code><xs:attribute name="URI" type="anyURI" use="optional"/></code>

attribute ReferenceType/@Type

type	xs:anyURI
properties	use optional
source	<code><xs:attribute name="Type" type="anyURI" use="optional"/></code>

complexType RetrievalMethodType

diagram																			
namespace	http://www.w3.org/2000/09/xmldsig#																		
children	ds:Transforms																		
used by	element RetrievalMethod																		
attributes	<table border="1"> <thead> <tr> <th>Name</th> <th>Type</th> <th>Use</th> <th>Default</th> <th>Fixed</th> <th>Annotation</th> </tr> </thead> <tbody> <tr> <td>URI</td> <td>xs:anyURI</td> <td></td> <td></td> <td></td> <td></td> </tr> <tr> <td>Type</td> <td>xs:anyURI</td> <td>optional</td> <td></td> <td></td> <td></td> </tr> </tbody> </table>	Name	Type	Use	Default	Fixed	Annotation	URI	xs:anyURI					Type	xs:anyURI	optional			
Name	Type	Use	Default	Fixed	Annotation														
URI	xs:anyURI																		
Type	xs:anyURI	optional																	
source	<code><xs:complexType name="RetrievalMethodType"></code>																		

	<pre> <xs:sequence> <xs:element ref="ds:Transforms" minOccurs="0"/> </xs:sequence> <xs:attribute name="URI" type="anyURI"/> <xs:attribute name="Type" type="anyURI" use="optional"/> </xs:complexType> </pre>
--	-----------------------------------------------------------------------------------------------------------------------------------------------------------------------------------------------------------------------------------------------------

attribute RetrievalMethodType/@URI

type	xs:anyURI
source	<xs:attribute name="URI" type="anyURI"/>

attribute RetrievalMethodType/@Type

type	xs:anyURI
properties	use optional
source	<xs:attribute name="Type" type="anyURI" use="optional"/>

complexType RSAKeyValue

diagram	
namespace	http://www.w3.org/2000/09/xmldsig#
children	ds:Modulus ds:Exponent
used by	element RSAKeyValue
source	<pre> <xs:complexType name="RSAKeyValue"> <xs:sequence> <xs:element name="Modulus" type="ds:CryptoBinary"/> <xs:element name="Exponent" type="ds:CryptoBinary"/> </xs:sequence> </xs:complexType> </pre>

element RSAKeyValue/Modulus

diagram	
namespace	http://www.w3.org/2000/09/xmldsig#
type	ds:CryptoBinary
properties	content simple
source	<xs:element name="Modulus" type="ds:CryptoBinary"/>

element **RSAKeyValue/Exponent**

diagram	
namespace	http://www.w3.org/2000/09/xmldsig#
type	ds:CryptoBinary
properties	content simple
source	<code><xs:element name="Exponent" type="ds:CryptoBinary"/></code>

complexType **SignatureMethodType**

diagram													
namespace	http://www.w3.org/2000/09/xmldsig#												
properties	mixed true												
children	ds:HMACOutputLength												
used by	element SignatureMethod												
attributes	<table border="1"> <thead> <tr> <th>Name</th> <th>Type</th> <th>Use</th> <th>Default</th> <th>Fixed</th> <th>Annotation</th> </tr> </thead> <tbody> <tr> <td>Algorithm</td> <td>xs:anyURI</td> <td>required</td> <td></td> <td></td> <td></td> </tr> </tbody> </table>	Name	Type	Use	Default	Fixed	Annotation	Algorithm	xs:anyURI	required			
Name	Type	Use	Default	Fixed	Annotation								
Algorithm	xs:anyURI	required											
source	<pre> <xs:complexType name="SignatureMethodType" mixed="true"> <xs:sequence> <xs:element name="HMACOutputLength" type="ds:HMACOutputLengthType" minOccurs="0"/> <xs:any namespace="##other" minOccurs="0" maxOccurs="unbounded"/> <!-- (0,unbounded) elements from (1,1) external namespace --> </xs:sequence> <xs:attribute name="Algorithm" type="anyURI" use="required"/> </xs:complexType> </pre>												

attribute **SignatureMethodType/@Algorithm**

type	xs:anyURI
properties	use required
source	<code><xs:attribute name="Algorithm" type="anyURI" use="required"/></code>

element **SignatureMethodType/HMACOutputLength**

diagram	
---------	--

namespace	http://www.w3.org/2000/09/xmldsig#
type	ds:HMACOutputLengthType
properties	minOcc 0 maxOcc 1 content simple
source	<code><xs:element name="HMACOutputLength" type="ds:HMACOutputLengthType" minOccurs="0"/></code>

complexType **SignaturePropertiesType**

diagram						
namespace	http://www.w3.org/2000/09/xmldsig#					
children	ds:SignatureProperty					
used by	element SignatureProperties					
attributes	Name	Type	Use	Default	Fixed	Annotation
	Id	xs:ID	optional			
source	<pre> <xs:complexType name="SignaturePropertiesType"> <xs:sequence> <xs:element ref="ds:SignatureProperty" maxOccurs="unbounded"/> </xs:sequence> <xs:attribute name="Id" type="ID" use="optional"/> </xs:complexType> </pre>					

attribute **SignaturePropertiesType/@Id**

type	xs:ID
properties	use optional
source	<code><xs:attribute name="Id" type="ID" use="optional"/></code>

complexType **SignaturePropertyType**

diagram						
namespace	http://www.w3.org/2000/09/xmldsig#					

properties	mixed true					
used by	element SignatureProperty					
attributes	Name Target	Type xs:anyURI	Use required	Default	Fixed	Annotation
	Id	xs:ID	optional			
source	<pre><xs:complexType name="SignaturePropertyType" mixed="true"> <xs:choice maxOccurs="unbounded"> <xs:any namespace="##other" processContents="lax"/> <!-- (1,1) elements from (1,unbounded) namespaces --> </xs:choice> <xs:attribute name="Target" type="anyURI" use="required"/> <xs:attribute name="Id" type="ID" use="optional"/> </xs:complexType></pre>					

attribute [SignaturePropertyType/@Target](#)

type	xs:anyURI
properties	use required
source	<pre><xs:attribute name="Target" type="anyURI" use="required"/></pre>

attribute [SignaturePropertyType/@Id](#)

type	xs:ID
properties	use optional
source	<pre><xs:attribute name="Id" type="ID" use="optional"/></pre>

complexType [SignatureType](#)

diagram	<pre> classDiagram class SignatureType { Id ds:SignedInfo ds:SignatureValue ds:KeyInfo ds:Object 0..∞ } </pre>
namespace	http://www.w3.org/2000/09/xmldsig#
children	ds:SignedInfo ds:SignatureValue ds:KeyInfo ds:Object
used by	element Signature
attributes	Name Type Use Default Fixed Annotation

	Id xs:ID optional
source	<pre><xs:complexType name="SignatureType"> <xs:sequence> <xs:element ref="ds:SignedInfo"/> <xs:element ref="ds:SignatureValue"/> <xs:element ref="ds:KeyInfo" minOccurs="0"/> <xs:element ref="ds:Object" minOccurs="0" maxOccurs="unbounded"/> </xs:sequence> <xs:attribute name="Id" type="ID" use="optional"/> </xs:complexType></pre>

attribute **SignatureType/@Id**

type	xs:ID
properties	use optional
source	<pre><xs:attribute name="Id" type="ID" use="optional"/></pre>

complexType **SignatureValueType**

diagram													
namespace	http://www.w3.org/2000/09/xmldsig#												
type	extension of xs:base64Binary												
properties	base base64Binary												
used by	element SignatureValue												
attributes	<table border="1"> <thead> <tr> <th>Name</th> <th>Type</th> <th>Use</th> <th>Default</th> <th>Fixed</th> <th>Annotation</th> </tr> </thead> <tbody> <tr> <td>Id</td> <td>xs:ID</td> <td>optional</td> <td></td> <td></td> <td></td> </tr> </tbody> </table>	Name	Type	Use	Default	Fixed	Annotation	Id	xs:ID	optional			
Name	Type	Use	Default	Fixed	Annotation								
Id	xs:ID	optional											
source	<pre><xs:complexType name="SignatureValueType"> <xs:simpleContent> <xs:extension base="base64Binary"> <xs:attribute name="Id" type="ID" use="optional"/> </xs:extension> </xs:simpleContent> </xs:complexType></pre>												

attribute **SignatureValueType/@Id**

type	xs:ID
properties	use optional
source	<pre><xs:attribute name="Id" type="ID" use="optional"/></pre>

complexType SignedInfoType

diagram						
namespace	http://www.w3.org/2000/09/xmldsig#					
children	ds:CanonicalizationMethod ds:SignatureMethod ds:Reference					
used by	element SignedInfo					
attributes	Name	Type	Use	Default	Fixed	Annotation
	Id	xs:ID	optional			
source	<pre><xs:complexType name="SignedInfoType"> <xs:sequence> <xs:element ref="ds:CanonicalizationMethod"/> <xs:element ref="ds:SignatureMethod"/> <xs:element ref="ds:Reference" maxOccurs="unbounded"/> </xs:sequence> <xs:attribute name="Id" type="ID" use="optional"/> </xs:complexType></pre>					

attribute SignedInfoType/@Id

type	xs:ID
properties	use optional
source	<pre><xs:attribute name="Id" type="ID" use="optional"/></pre>

complexType SPKIDataType

diagram						
namespace	http://www.w3.org/2000/09/xmldsig#					
children	ds:SPKISexp					
used by	element SPKIData					
source	<pre><xs:complexType name="SPKIDataType"> <xs:sequence maxOccurs="unbounded"> <xs:element name="SPKISexp" type="base64Binary"/> <xs:any namespace="##other" processContents="lax" minOccurs="0"/> </xs:sequence></pre>					

	<code></xs:complexType></code>
--	--------------------------------------

element **SPKIDataType/SPKISexp**

diagram	
namespace	http://www.w3.org/2000/09/xmldsig#
type	xs:base64Binary
properties	content simple
source	<code><xs:element name="SPKISexp" type="base64Binary"/></code>

complexType **TransformsType**

diagram	
namespace	http://www.w3.org/2000/09/xmldsig#
children	ds:Transform
used by	element Transforms
source	<code><xs:complexType name="TransformsType"> <xs:sequence> <xs:element ref="ds:Transform" maxOccurs="unbounded"/> </xs:sequence> </xs:complexType></code>

complexType **TransformType**

diagram													
namespace	http://www.w3.org/2000/09/xmldsig#												
properties	mixed true												
children	ds:XPath												
used by	element Transform												
attributes	<table border="1"> <thead> <tr> <th>Name</th> <th>Type</th> <th>Use</th> <th>Default</th> <th>Fixed</th> <th>Annotation</th> </tr> </thead> <tbody> <tr> <td>Algorithm</td> <td>xs:anyURI</td> <td>required</td> <td></td> <td></td> <td></td> </tr> </tbody> </table>	Name	Type	Use	Default	Fixed	Annotation	Algorithm	xs:anyURI	required			
Name	Type	Use	Default	Fixed	Annotation								
Algorithm	xs:anyURI	required											
source	<code><xs:complexType name="TransformType" mixed="true"> <xs:choice minOccurs="0" maxOccurs="unbounded"> <xs:any namespace="##other" processContents="lax"/> </xs:choice> </xs:complexType></code>												

	<pre> <!-- (1,1) elements from (0,unbounded) namespaces --> <xs:element name="XPath" type="string"/> </xs:choice> <xs:attribute name="Algorithm" type="anyURI" use="required"/> </xs:complexType> </pre>
--	----------------------------------------------------------------------------------------------------------------------------------------------------------------------------------------------------------------------------------------

attribute TransformType/@Algorithm

type	xs:anyURI
properties	use required
source	<xs:attribute name="Algorithm" type="anyURI" use="required"/>

element TransformType/XPath

diagram	
namespace	http://www.w3.org/2000/09/xmldsig#
type	xs:string
properties	content simple
source	<xs:element name="XPath" type="string"/>

complexType X509DataType

diagram	
namespace	http://www.w3.org/2000/09/xmldsig#
children	ds:X509IssuerSerial ds:X509SKI ds:X509SubjectName ds:X509Certificate ds:X509CRL
used by	element X509Data
source	<pre> <xs:complexType name="X509DataType"> <xs:sequence maxOccurs="unbounded"> <xs:choice> <xs:element name="X509IssuerSerial" type="ds:X509IssuerSerialType"/> <xs:element name="X509SKI" type="base64Binary"/> <xs:element name="X509SubjectName" type="string"/> <xs:element name="X509Certificate" type="base64Binary"/> <xs:element name="X509CRL" type="base64Binary"/> </xs:choice> </xs:sequence> </xs:complexType> </pre>

```

<xs:any namespace="##other" processContents="lax"/>
</xs:choice>
</xs:sequence>
</xs:complexType>

```

element X509DataType/X509IssuerSerial

diagram	
namespace	http://www.w3.org/2000/09/xmldsig#
type	ds:X509IssuerSerialType
properties	content complex
children	ds:X509IssuerName ds:X509SerialNumber
source	<code><xs:element name="X509IssuerSerial" type="ds:X509IssuerSerialType"/></code>

element X509DataType/X509SKI

diagram	
namespace	http://www.w3.org/2000/09/xmldsig#
type	xs:base64Binary
properties	content simple
source	<code><xs:element name="X509SKI" type="base64Binary"/></code>

element X509DataType/X509SubjectName

diagram	
namespace	http://www.w3.org/2000/09/xmldsig#
type	xs:string
properties	content simple
source	<code><xs:element name="X509SubjectName" type="string"/></code>

element X509DataType/X509Certificate

diagram	
---------	--

namespace	http://www.w3.org/2000/09/xmldsig#
type	xs:base64Binary
properties	content simple
source	<code><xs:element name="X509Certificate" type="base64Binary"/></code>

element X509DataType/X509CRL

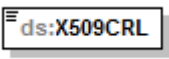
diagram	
namespace	http://www.w3.org/2000/09/xmldsig#
type	xs:base64Binary
properties	content simple
source	<code><xs:element name="X509CRL" type="base64Binary"/></code>

complexType X509IssuerSerialType

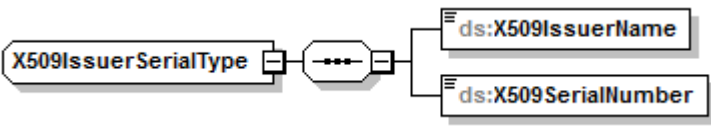
diagram	
namespace	http://www.w3.org/2000/09/xmldsig#
children	ds:X509IssuerName ds:X509SerialNumber
used by	element X509DataType/X509IssuerSerial
source	<code><xs:complexType name="X509IssuerSerialType"> <xs:sequence> <xs:element name="X509IssuerName" type="string"/> <xs:element name="X509SerialNumber" type="integer"/> </xs:sequence> </xs:complexType></code>

element X509IssuerSerialType/X509IssuerName

diagram	
namespace	http://www.w3.org/2000/09/xmldsig#
type	xs:string
properties	content simple
source	<code><xs:element name="X509IssuerName" type="string"/></code>

element **X509IssuerSerialType/X509SerialNumber**

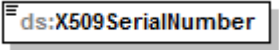
diagram	
namespace	http://www.w3.org/2000/09/xmldsig#
type	xs:integer
properties	content simple
source	<code><xs:element name="X509SerialNumber" type="integer"/></code>

simpleType **CryptoBinary**

namespace	http://www.w3.org/2000/09/xmldsig#
type	xs:base64Binary
properties	base base64Binary
used by	elements RSAKeyValue/Exponent DSAKeyValue/G DSAKeyValue/J RSAKeyValue/Modulus DSAKeyValue/P DSAKeyValue/PgenCounter DSAKeyValue/Q DSAKeyValue/Seed DSAKeyValue/Y
source	<code><xs:simpleType name="CryptoBinary"> <xs:restriction base="base64Binary"/> </xs:simpleType></code>

simpleType **DigestValueType**

namespace	http://www.w3.org/2000/09/xmldsig#
type	xs:base64Binary
properties	base base64Binary
used by	element DigestValue
source	<code><xs:simpleType name="DigestValueType"> <xs:restriction base="base64Binary"/> </xs:simpleType></code>

simpleType **HMACOutputLengthType**

namespace	http://www.w3.org/2000/09/xmldsig#
type	xs:integer
properties	base integer
used by	element SignatureMethodType/HMACOutputLength
source	<code><xs:simpleType name="HMACOutputLengthType"> <xs:restriction base="integer"/> </xs:simpleType></code>